

E1W LEAD SEAL

CAPTIVE COMPONENT GLAND®

for Lead Sheathed Armoured Cable



Features and Benefits

- For indoor and outdoor use.
- Freely rotating captive cone and inspectible cone ring, providing an armour clamp and earth bond without twisting the armour wire with patented disconnect system for armour clamp inspection.
- Seals on both the inner lead sheath and outer sheath of the cable to IP65/66/68.
- Precision manufactured from high-quality brass (Nickel Plated) available in aluminium or stainless steel 316/316L on request.
- Complete with thread sealing gasket and heavy-duty locknut.



Technical Data

Type:	E1W Lead Seal
Gland Material:	Brass (Nickel Plated), BS 2874, EN 12164, Aluminium ASTM BS221, Stainless 316/316L
Seal Material:	Thermoset Elastomer and Lead
Cable Type:	Steel Wire Armour and Lead Seal
Armour Clamping:	Rotating Captive Cone and Inspectible Cone Ring
Sealing Area:	Inner Lead Sheath and Outer Sheath
Optional Accessories:	Adaptor, Reducer, Earth Tag, Locknut, Serrated Washer and Shroud

Standards and Certifications

Mechanical Properties:	Impact Category 8 Anchorage Type D	
Electrical Properties:	Category A (no earth tag) Category B (with earth tag)	
Continuous Operating Temp:	-65°C to +120°C	
Conformance:	Standard:	Certificate:
Design Standards	BS 6121:Part 1	CML 14CA364
	EN 50262	CML 14CA364
	IEC/BS EN 62444	CML 14CA364
	SANS 62444	MASC 22-9012
	SANS 1213	MASC 18-2047, SANS 2109/4596
IP66/68 2m - Parallel	IEC 60529	MASC 22-9015
IP65 - Tapered	IEC 60529	
Marine ABS	IEC 60529, IEC 62444	ABS 20-SG1952694-PDA
EMC Compatible	EN 55011, + A1, EN 55022	SGS EMC305079/1

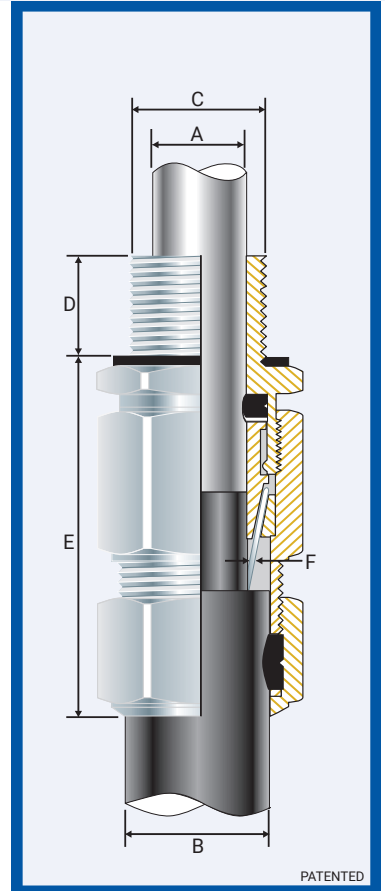

Installation Standards

- AS/NZS 3000
- BS 6121-5
- BS 7671
- BS 7430
- IEC 60364-5-54
- SANS 0142

Product Code	Gland Size Reference	Metric Entry Thread		NPT Entry Thread		Cable Detail				Max Length 'E'	Armour Dia		Hexagonal Detail		Install. Torque Value Nm
		'C'	Min 'D'	'C'	Min 'D'	Lead Sheath		Min 'B'	Max 'B'		Min 'F'	Max 'F'	Max 'Flats'	Max 'Crns'	
						Min 'A'	Max 'A'								
051800-LS	00-20ss	M20x1.5	10	1/2/3/4	15	3.0	8.0	8.0	13.5	46.0	0.90	0.90	♦ 24/27	♦ 27/30	35.0
051801-LS	0-20s	M20x1.5	10	1/2/3/4	15	8.0	12.0	11.5	16.0	46.0	0.90	1.25	♦ 24/27	♦ 27/30	35.0
051802-LS	1-20	M20x1.5	10	1/2/3/4	15	9.0	15.0	14.5	20.5	52.0	0.90	1.25	27	30	35.0
051803-LS	2s-25s	M25x1.5	10	3/4/1	15/19	13.0	16.5	16.0	24.5	65.0	0.90	1.60	35	39	50.0
051804-LS	2-25	M25x1.5	10	3/4/1	15/19	13.0	16.5	20.5	26.5	65.0	1.25	1.60	35	39	50.0
051805-LS	3s-32s	M32x1.5	10	1/1 1/4	19	16.0	19.0	23.0	30.5	65.0	1.25	2.00	42	47	70.0
051806-LS	3-32	M32x1.5	10	1/1 1/4	19	18.0	20.5	26.5	33.5	65.0	1.60	2.00	42	47	70.0
051807-LS	4s-40s	M40x1.5	15	1 1/4/1 1/2	19/21	20.5	25.0	30.0	39.5	76.0	1.60	2.00	52	59	90.0
051808-LS	4-40	M40x1.5	15	1 1/4/1 1/2	19/21	25.0	29.0	33.0	42.5	76.0	1.60	2.00	52	59	90.0
051809-LS	5s-50s	M50x1.5	15	1 1/2/2	21	28.5	34.0	34.0	47.5	86.0	1.60	2.50	65	73	100.0
051810-LS	5-50	M50x1.5	15	1 1/2/2	21	33.5	36.0	42.5	52.5	86.0	2.00	2.50	65	73	100.0
051811-LS	6s-63s	M63x1.5	15	2/2 1/2	21/30	35.5	39.0	45.5	60.5	107.0	2.00	2.50	80	90	120.0
051812-LS	6m-63m	M63x1.5	15	2/2 1/2	21/30	38.5	42.0	52.5	65.5	107.0	2.00	2.50	80	90	120.0
051813-LS	6L-63L	M63x1.5	15	2/2 1/2	21/30	41.5	44.0	52.5	65.5	107.0	2.00	2.50	80	90	120.0
051814-LS	7s-75s	M75x1.5	15	2 1/2/3	30/32	43.0	49.0	57.0	72.5	124.0	2.50	3.15	96	108	120.0
051815-LS	7m-75m	M75x1.5	15	2 1/2/3	30/32	49.0	56.0	65.5	78.0	124.0	2.50	3.15	96	108	120.0
051816-LS	7L-75L	M75x1.5	15	2 1/2/3	30/32	56.0	59.0	65.5	78.0	124.0	2.50	3.15	96	108	120.0
051817-LS	8-80	M80x2.0	15	3	32	59.0	66.0	65.0	77.5	175.0	3.00	3.15	96	108	120.0
051818-LS	9s-90s	M90x2.0	15	3 3/3 1/2	32/33	66.0	73.0	73.0	86.5	184.0	3.00	4.00	111	125	120.0
051819-LS	9-90	M90x2.0	15	3 3/3 1/2	32/33	73.0	79.0	82.0	90.5	184.0	3.00	4.00	111	125	120.0
051820-LS	10-100	M100x2.0	15	3 1/2/4	33/34	78.0	88.0	91.0	100.0	189.0	3.00	4.00	125	141	120.0
051821-LS	11-115	M115x2.0	15	4	34	86.0	96.0	100.0	114.0	189.0	3.00	4.00	135	152	175.0
051822-LS	12-120	M120x2.0	15	-	-	96.0	100.0	103.0	118.0	189.0	3.00	4.00	140	158	175.0
051823-LS	13-130	M130x2.0	15	-	-	100.0	112.0	113.0	124.0	189.0	3.00	4.00	146	164	175.0

All dimensions except NPT are in mm.

* When manufactured in Aluminium, Hex will be 27 Across Flats and 30 Across Corners.

CCG reserves the right to make alterations to the technical data, dimensions, designs and products available without notice. The illustrations cannot be considered binding. Please contact CCG for assistance.

E1WLS-EMC010424E

E1W LEAD SEAL CAPTIVE COMPONENT GLAND®

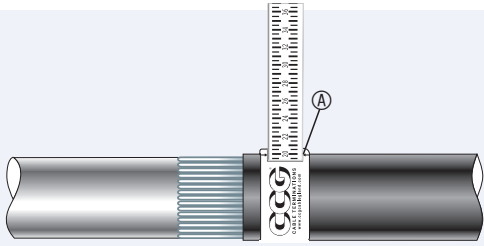

1. For accurate sizing, use a CCG Dimension Tape (A) on the inner and outer cable sheath.

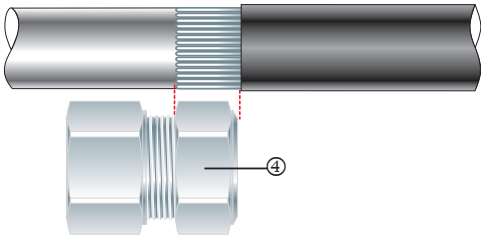

2. Cut back the cable outer sheath to expose the armour to a length not more than the outer nut (4). Cut back the inner sheath to just before the armouring to expose lead sheath.

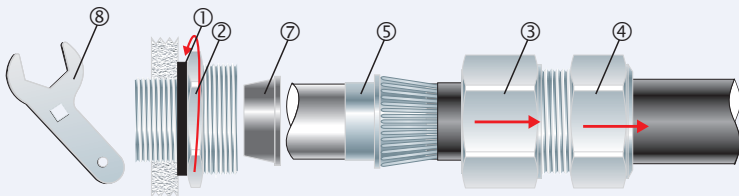

3. To maintain IP66/68 ensure the gasket (1) is in place. Screw the gland unit into the apparatus. Tighten the inner (2) to the installation torque using a CCG Spanner (8). Pass the outer nut (4) and the body (3) over the cable. Splay the armour wires over the cone (5). Pass the lead through the lead seal (7) over sheath.

Alternative installation through an unthreaded entry.

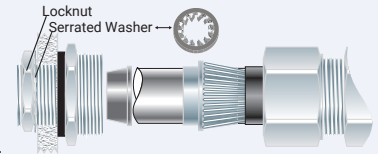

If the apparatus is untapped use a locknut.

If the gland has NPT entry threads fitted to a threaded entry then IP68 (2m) can be achieved by applying one of the following tested and approved grease types to the thread:- Renolit Lubrene CA700 or LX220 EP2, Renolit LC-WP2 or Moly LX2, or Dow Corning 4 Electrical Compound.

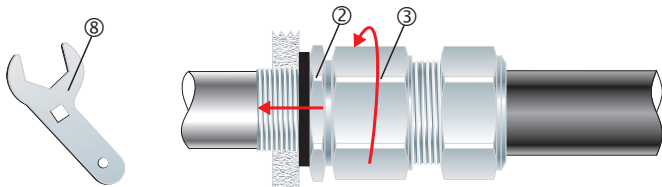

4. Pass the cable end through the inner (2). Tighten the body (3) onto the inner (2) until hand tight, then tighten with a CCG Spanner (8) with $\frac{3}{4}$ turn to lock the armour between the cone (5) and the cone ring (6).

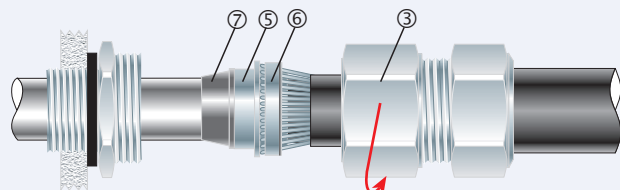

5. Unscrew the body (3) and check that lead seal (7) has bonded onto the lead of the cable (lead seal must be tight). Check that the armour has locked between the cone (5) and the cone ring (6) (O-Ring on the cone ring (6) is sacrificial).

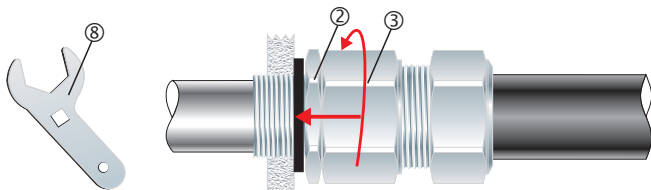

6. Pass the cable end through the inner (2). Tighten the body (3) onto the inner (2) to installation torque using a CCG Spanner (8).

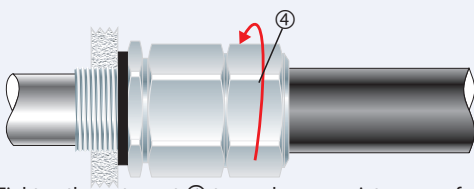

7. Tighten the outer nut (4) to produce a moisture proof seal by turning until the seal makes contact with the outer sheath of the cable and then make one full turn.