

CW

CAPTIVE COMPONENT GLAND®

for Steel Wire and Aluminium Armoured Cable



Features and Benefits

- For indoor and outdoor use.
- Two-piece handling, no loose parts.
- Freely rotating captive cone and inspectible cone ring, providing an inspectible armour clamp and earth bond without twisting the armouring.
- Patented disconnect armoured clamp system for ease of inspection.
- Provides a seal on the outer sheath of the cable sealing to IP65/66.
- Precision manufactured from high-quality brass (nickel plated) available in aluminium or stainless steel 316/316L on request.
- Complete with thread sealing gasket and heavy-duty locknut.

Technical Data

Type:	CW
Gland Material:	Brass (Nickel Plated) BS 2874, EN 12164, Aluminium ASTM B221, Stainless Steel 316/316L
Seal Material:	Thermoset Elastomer or Silicon on request
Cable Type:	Steel Wire Armour and Aluminium Armour Wire
Armour Clamping:	Rotating Captive Cone and Inspectible Cone Ring
Sealing Area:	Outer Sheath
Optional Accessories:	Adaptor, Reducer, Earth Tag, Locknut, Serrated Washer and Shroud

Standards and Certifications

Mechanical Properties:	Impact Category 8, Anchorage Type D	
Electrical Properties:	Category A (no earth tag) Category B (with earth tag)	
Continuous Operating Temp:	-65°C to +120°C	
Conformance:	Standard:	Certificate:
Design Standards	BS 6121:Part 1	CML 14CA364
	IEC/BS EN 62444	CML 14CA364
	SANS 62444	MASC 22-9012
	SANS 1213	MASC 18-2047, SANS 2109/4596
	IEC 60529	MASC 22-9015
IP66 - Parallel	IEC 60529	
IP65 - Tapered	IEC 60529	
Marine ABS	IEC 60529, IEC 62444	ABS 20-SG1952694-PDA
	DNV	TAE000000Z
EMC Compatible	EN 55011, + A1, EN 55022	SGS EMC305079/1
London Underground Approval	BS EN 62444	LU 3043

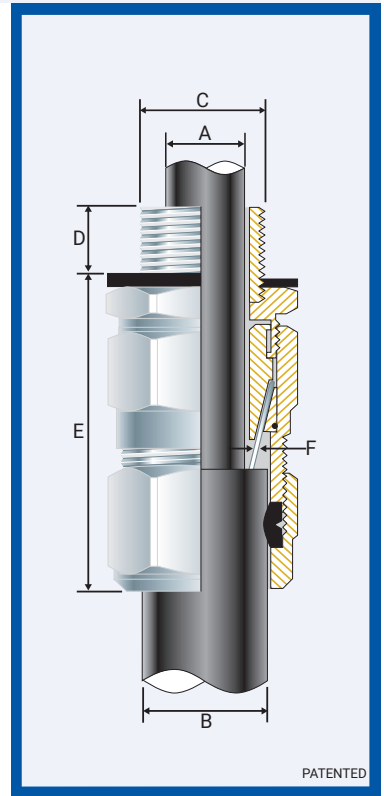

Installation Standards

- AS/NZS 3000
- BS 7671
- IEC 60364-5-54
- BS 6121-5
- BS 7430
- SANS 0142

Product Code	Gland Size Reference	Metric Entry Thread		NPT Entry Thread		Cable Detail			Max Length 'E'	Armour Dia		Hexagonal Detail		Install Torque Value Nm
		'C'	Min 'D'	'C'	Min 'D'	Max 'A'	Min 'B'	Max 'B'		Min 'F'	Max 'F'	Max 'Flats'	Max 'Crns'	
051200-16	◆* 00-16ss	M16x1.5	10	-	-	8.5	8.0	13.5	41.0	0.90	0.90	◆ 24.0	◆ 27.0	35.0
051200	◆* 00-20ss	M20x1.5	10	1/2/3/4	15	8.5	8.0	13.5	41.0	0.90	0.90	◆ 24.0	◆ 27.0	35.0
0512-0	◆* 0-20s	M20x1.5	10	1/2/3/4	15	12.0	11.5	16.0	43.0	0.90	1.25	◆ 24.0	◆ 27.0	35.0
051201	* 1-20	M20x1.5	10	1/2/3/4	15	15.0	14.5	20.5	47.0	0.90	1.25	▲ 27.0	▲ 30.0	35.0
051222	* 2s-25s	M25x1.5	10	3/4/1	15/19	17.5	16.0	24.5	56.0	1.25	1.60	▲ 35.0	▲ 39.0	50.0
051202	* 2-25	M25x1.5	10	3/4/1	15/19	20.0	20.5	26.5	56.0	1.25	1.60	▲ 35.0	▲ 39.0	50.0
051233	* 3s-32s	M32x1.5	10	1/1 1/4	19	22.0	23.0	30.5	57.0	1.60	2.00	▲ 42.0	▲ 47.0	70.0
051203	* 3-32	M32x1.5	10	1/1 1/4	19	26.5	26.5	33.5	57.0	1.60	2.00	▲ 42.0	▲ 47.0	70.0
051244	4s-40s	M40x1.5	15	1 1/4/1 1/2	19/21	31.5	30.0	39.5	68.0	1.60	2.00	▲ 52.0	▲ 59.0	90.0
051204	4-40	M40x1.5	15	1 1/4/1 1/2	19/21	34.0	33.0	42.5	68.0	1.60	2.00	▲ 52.0	▲ 59.0	90.0
051255	5s-50s	M50x1.5	15	1 1/2/2	21	38.0	34.0	47.5	72.0	2.00	2.50	▲ 65.0	▲ 73.0	100.0
051205	5-50	M50x1.5	15	1 1/2/2	21	38.0/44.5	42.5	52.5	72.0	2.00	2.50	▲ 65.0	▲ 73.0	100.0
051266	6s-63s	M63x1.5	15	2/2 1/2	21/30	50.0	45.5	60.5	89.0	2.00	2.50	▲ 80.0	▲ 90.0	120.0
051206	6-63	M63x1.5	15	2/2 1/2	21/30	50.0/56.5	52.5	65.5	89.0	2.00	2.50	▲ 80.0	▲ 90.0	120.0
051277	7s-75s	M75x1.5	15	2 1/2/3	30/ 32	62.0	57.0	72.5	97.0	2.50	3.15	▲ 96.0	▲ 108.0	120.0
051207	7-75	M75x1.5	15	2 1/2/3	30/32	62.0/67.5	65.5	78.0	97.0	2.50	3.15	▲ 96.0	▲ 108.0	120.0
051288	8s-80s	M80x2.0	20	3	32	69.0	65.0	77.5	98.0	2.50	3.15	▲ 96.0	▲ 108.0	120.0
051208	8-80	M80x2.0	20	3	32	74.0	78.0	82.0	98.0	2.50	3.15	▲ 96.0	▲ 108.0	120.0
051299	9s-90s	M90x2.0	20	3/3 1/2	32/33	75.0	73.0	86.5	123.0	3.00	3.50	▲ 96.0	▲ 108.0	120.0
051209	9-90	M90x2.0	20	3/3 1/2	32/33	75.0/81.5	82.0	91.0	123.0	3.00	3.50	▲ -	▲ -	120.0
051210	10-100	M100x2.0	20	3 1/2/4	33/34	91.0	90.0	100.0	124.0	3.00	3.50	▲ -	▲ -	120.0
051211	11-110	M110x2.0	20	4	34	98.0	100.0	114.0	134.0	3.00	4.00	▲ -	▲ -	120.0
051212	12-120	M120x2.0	20	-	-	103.0	103.0	118.0	136.0	3.00	4.00	▲ -	▲ -	120.0
051213	13-130	M130x2.0	20	-	-	115.0	113.0	124.0	140.0	3.00	4.00	▲ -	▲ -	120.0

All dimensions except NPT are in mm. * Supplied with fixed cone and bush.

* For use with CCG Handi Fit Boxes. ▲ For use with CCG Hex Spanner. ◆ For use with CCG C-Spanner.

◆ When manufactured in Aluminium, Hex will be 27 Across Flats and 30 Across Corners.

CCG reserves the right to make alterations to the technical data, dimensions, designs and products available without notice. The illustrations cannot be considered binding. Please contact CCG for assistance.

CW-IN080324

CW CAPTIVE COMPONENT GLAND®

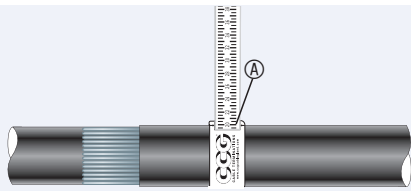

1. For accurate sizing, use a CCG Dimension Tape (A) on the inner and outer cable sheath.

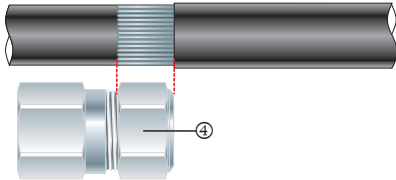

2. Cut back the cable outer sheath to expose the armour to a length not more than the outer nut (4).

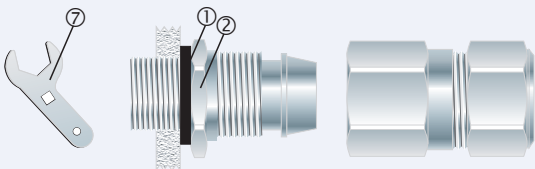

3. To maintain IP66, ensure the gasket (1) is in place. Screw the inner (2) into the apparatus. Tighten the inner (2) to the installation torque using a CCG Spanner (7).

Alternative installation through an unthreaded entry.

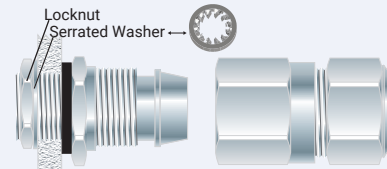

If the apparatus is untapped use a locknut.

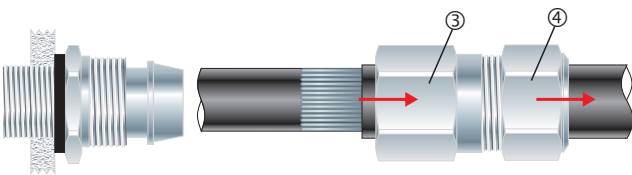

4. Pass the outer nut (4) and body (3) over the cable.

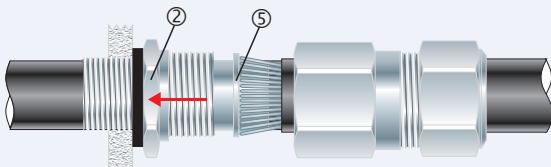

5. Pass cable end through the inner (2) and splay the armour wires over the cone (5).

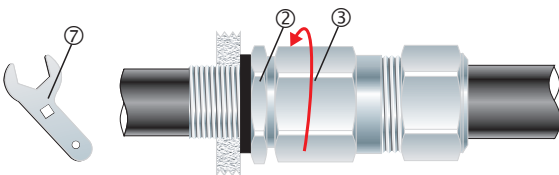

6. Tighten the body (3) onto the inner (2) until hand tight, then tighten with a CCG Spanner (7) with $\frac{3}{4}$ turn to lock the armour between the cone (5) and the cone ring (6).

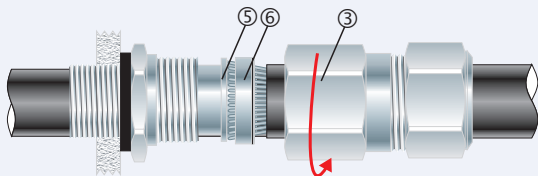

7. Unscrew the body (3). Check that the armour has locked between the cone (5) and the cone ring (6). (O-Ring on the cone ring (6) is sacrificial).

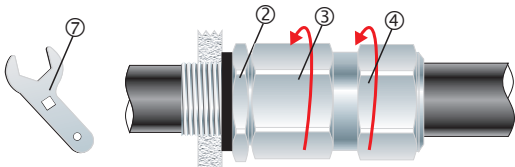

8. Screw the body (3) onto the inner (2) and tighten the body (3) to the installation torque using a CCG Spanner (7). Tighten the outer nut (4) to produce a moisture proof seal by turning until the seal makes contact with the outer sheath of cable and then turn one full turn.