



E1W

CAPTIVE COMPONENT GLAND®

for Steel and Aluminium Armoured Cable

Features and Benefits

- For indoor and outdoor use.
- Two-piece handling, no loose parts.
- Freely rotating captive cone and inspectible cone ring, providing an armour clamp and earth bond without twisting the armour wire.
- Patented disconnect system for armour clamp inspection. Factory fitted captive elastomeric inner seal for Built-in Safety™. Seals on both the inner and outer sheath of the cable to IP65/66/68.
- Precision manufactured from high-quality brass (Nickel Plated) available in aluminium or stainless steel 316/316L on request.
- Complete with thread sealing gasket and with a heavy-duty locknut.



Technical Data

Type:	E1W
Gland Material:	Brass (Nickel Plated), BS 2874, EN 12164, Aluminium ASTM BS221, Stainless Steel 316/316L
Seal Material:	Thermoset Elastomer or Silicone on request
Cable Type:	Steel Wire Armour and Aluminium Armour Wire
Armour Clamping:	Rotating Captive Cone and Inspectible Cone Ring
Sealing Area:	Inner Sheath and Outer Sheath
Optional Accessories:	Adaptor, Reducer, Earth Tag, Locknut, Serrated Washer and Shroud

Standards and Certifications

Mechanical Properties:	Impact Category 8 Anchorage Type D	
Electrical Properties:	Category A (no earth tag) Category B (with earth tag)	
Continuous Operating Temp:	-65°C to +120°C	
Conformance:	Standard:	Certification:
Design Standards	BS 6121:Part 1 EN 50262 IEC/BS EN 62444 SANS 62444 SANS 1213	CML 14CA364 CML 14CA364 CML 14CA364 MASC 22-9012 MASC 18-2047, SANS 2109/4596 CML 15Y728, MASC 22-9015
IP66/68 100m - Parallel	IEC 60529	
IP65 - Tapered	IEC 60529	
Marine ABS	IEC 60529, IEC 62444	ABS 20-SG1952694-PDA
DNV-GL	IEC 60529, BS 6121, IEC 62444	DNV-GL TAE000000Z
EMC Compatible	EN 55011, A1, EN 55022	SGS EMC305079/1
London Underground Approval	BS EN 62444	LU 3043

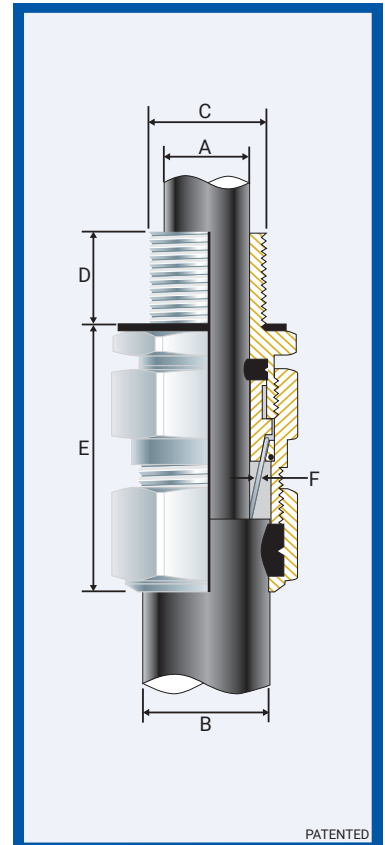

Installation Standards

- AS/NZS 3000
- BS 7671
- IEC 60364-5-54
- BS 6121-5
- BS 7430
- SANS 0142

Product Code	Gland Size Reference	Metric Entry Thread		NPT Entry Thread		Cable Detail				Max Length 'E'	Armour Dia		Hexagonal Detail		Install Torque Value Nm
		'C'	Min 'D'	'C'	Min 'D'	Min 'A'	Max 'A'	Min 'B'	Max 'B'		Min 'F'	Max 'F'	Max 'Flats'	Max 'Crns'	
051800-16	00-16ss	M16x1.5	10	-	-	3.0	8.5	8.0	13.5	52.0	0.90	0.90	24.0	27.0	35.0
051800	00-20ss	M20x1.5	10	1/2	15	3.0	8.5	8.0	13.5	52.0	0.90	0.90	24.0	27.0	35.0
0518-0	0-20s	M20x1.5	10	1/2	15	7.0	12.0	11.5	16.0	52.0	0.90	1.25	24.0	27.0	35.0
051801	1-20	M20x1.5	10	1/2/3/4	15	11.0	15.0	14.5	20.5	56.0	0.90	1.25	27.0	30.0	35.0
051822	2s-25s	M25x1.5	10	3/4/1	15/19	11.0	17.5	16.0	24.5	65.0	1.25	1.60	35.0	39.0	50.0
051802	2-25	M25x1.5	10	3/4/1	15/19	14.0	20.0	20.5	26.5	65.0	1.25	1.60	35.0	39.0	50.0
051833	3s-32s	M32x1.5	10	1/1 1/4	19	15.0	22.0	23.0	30.5	65.0	1.60	2.00	42.0	47.0	70.0
051803	3-32	M32x1.5	10	1/1 1/4	19	19.0	26.5	26.5	33.5	65.0	1.60	2.00	42.0	47.0	70.0
051844	4s-40s	M40x1.5	15	1 1/4/1 1/2	19/21	22.0	31.5	30.0	39.5	80.0	1.60	2.00	52.0	59.0	90.0
051804	4-40	M40x1.5	15	1 1/4/1 1/2	19/21	26.0	34.0	33.0	42.5	80.0	1.60	2.00	52.0	59.0	90.0
051855	5s-50s	M50x1.5	15	1 1/2/2	21	29.0	38.0	34.0	47.5	95.0	2.00	2.50	65.0	73.0	100.0
051805	5-50	M50x1.5	15	1 1/2/2	21	34.0	44.5	42.5	52.5	95.0	2.00	2.50	65.0	73.0	100.0
051866	6s-63s	M63x1.5	15	2/2 1/2	30	38.0	50.0	45.5	60.5	116.0	2.00	2.50	80.0	90.0	120.0
051806	6-63	M63x1.5	15	2/2 1/2	30	44.0	56.5	52.5	65.5	116.0	2.00	2.50	80.0	90.0	120.0
051877	7s-75s	M75x1.5	15	2 1/2/3	32	50.0	62.0	57.0	72.5	127.0	2.50	3.15	96.0	108.0	120.0
051807	7-75	M75x1.5	15	2 1/2/3	32	56.0	67.5	65.5	78.0	127.0	2.50	3.15	96.0	108.0	120.0
051808	8-80	M80x2.0	20	3	32	68.0	74.0	78.0	82.0	120.0	2.50	3.15	96.0	108.0	120.0
051899	9s-90s	M90x2.0	20	3/3 1/2	32/33	66.0	75.0	73.0	86.5	142.0	3.00	3.50	111.0	125.0	120.0
051809	9-90	M90x2.0	20	3/3 1/2	32/33	74.0	81.5	82.0	91.0	142.0	3.00	3.50	111.0	125.0	120.0
051810	10-100	M100x2.0	20	3 1/2/4	33/34	81.0	91.0	90.0	100.0	142.0	3.00	3.50	125.0	141.0	120.0
051811	11-110	M110x2.0	20	4	34	86.0	98.0	100.0	114.0	142.0	3.00	4.00	135.0	152.0	120.0
051812	12-120	M120x2.0	20	-	-	96.0	103.0	103.0	118.0	142.0	3.00	4.00	140.0	158.0	120.0
051813	13-130	M130x2.0	20	-	-	100.0	115.0	113.0	124.0	165.0	3.00	4.00	146.0	164.0	120.0

All dimensions except NPT are in mm.

* When manufactured in Aluminium, Hex will be 27 Across Flats and 30 Across Corners.

CCGG reserves the right to make alterations to the technical data, dimensions, designs and products available without notice. The illustrations cannot be considered binding. Please contact CCGG for assistance.

E1W-IN100922E

E1W CAPTIVE COMPONENT GLAND®

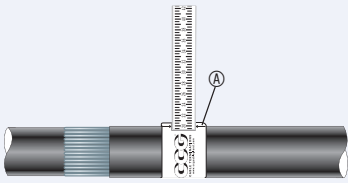

1. For accurate sizing, use a CCG Dimension Tape (A) on the inner and outer cable sheath.

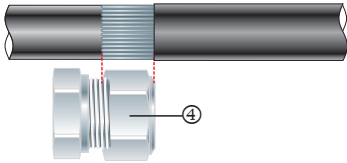

2. Cut back the cable outer sheath to expose the armour to a length not more than the outer nut (4).

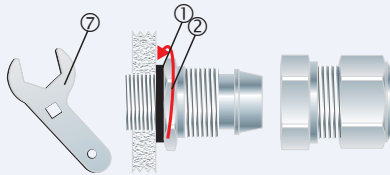

3. To maintain IP66/68, ensure the gasket (1) is in place. Screw the inner (2) into the apparatus. Tighten the inner (2), to installation torque using a CCG Spanner (7).

Alternative installation through an unthreaded entry.

If the apparatus is untapped use a locknut.

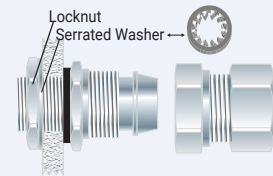

If the gland has NPT entry threads fitted to a threaded entry then IP68 (2m) can be achieved by applying one of the following tested and approved grease types to the thread:- Renolit Lubrene CA700 or LX220 EP2, Renolit LC-WP2 or Moly LX2, or Dow Corning 4 Electrical Compound.

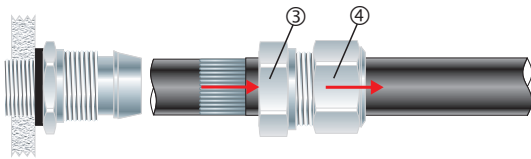

4. Pass the outer nut (4) and the body (3) over the cable.

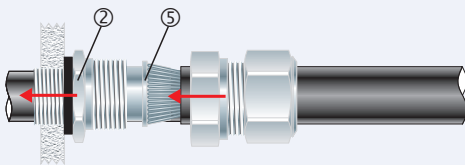

5. Pass cable end through the inner (2) and splay the armour wires over the cone (5).

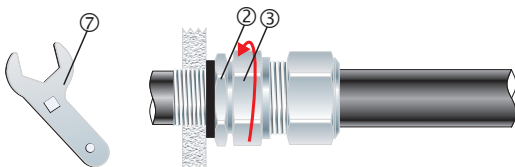

6. Tighten the body (3) onto the inner (2) until hand tight, then tighten with a CCG Spanner (7) with $\frac{3}{4}$ turn to lock the armour between the cone (5) and the cone ring (6).

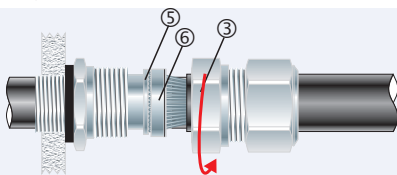

7. Unscrew the body (3). Check that the armour has locked between the cone (5) and the cone ring (6). (O-Ring on the cone ring (6) is sacrificial)

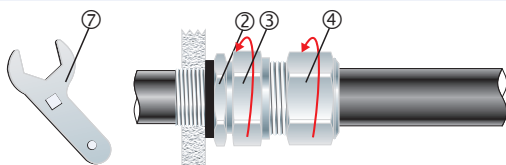

8. Tighten the body (3) onto the inner (2) to the installation torque using a CCG Spanner (7). Tighten the outer nut (4) to produce a moisture proof seal by turning until the seal makes contact with the outer sheath of cable and then turn one full turn.