

A2

COMPRESSION GLAND

for Unarmoured Cable



Features and Benefits

- For indoor and outdoor use.
- Seals the cable sheath to IP66/68.
- Specially formulated elastomeric seals.
- Precision manufactured from high-quality brass (Nickel Plated) available in aluminium or stainless steel 316/316L on request.
- Complete with a heavy-duty locknut.
- Supplied with a thread-sealing gasket (parallel threads only).



Technical Data

Type:	A2	
Gland Material:	Brass (Nickel Plated) BS 2874, EN 12164, Aluminium ASTM BS221, Stainless Steel 316/316L	
Seal Material:	Thermoset Elastomer or Silicon on request.	
Cable Type:	Unarmoured	
Sealing Area:	Outer Sheath	
Optional Accessories:	Adaptor, Reducer, Earth Tag, Locknut, Serrated Washer and Shroud	
Standards and Certifications		
Mechanical Properties:	Impact Category 8 Anchorage Type B	
Continuous Operating Temp:	-65°C to +120°C	
Conformance:	Standard:	Certificate:
Design Standards	BS 6121:Part 1 EN 50262 IEC/BS EN 62444 SANS 62444 SANS 1213	CML 14CA364 CML 14CA364 CML 14CA364 MASC 22-9012 MASC 18-2047, SANS 2109/4596 CML 15Y728, MASC 22-9015
IP66/68 100m - Parallel	IEC 60529	
IP65 - Tapered	IEC 60529	
Marine ABS	IEC 60529, IEC 62444	ABS 20-SG1952694-PDA
DNV	IEC 60529, BS 6121, IEC 62444	TAE000000Z
London Underground Approval	BS EN 62444	LU 3043

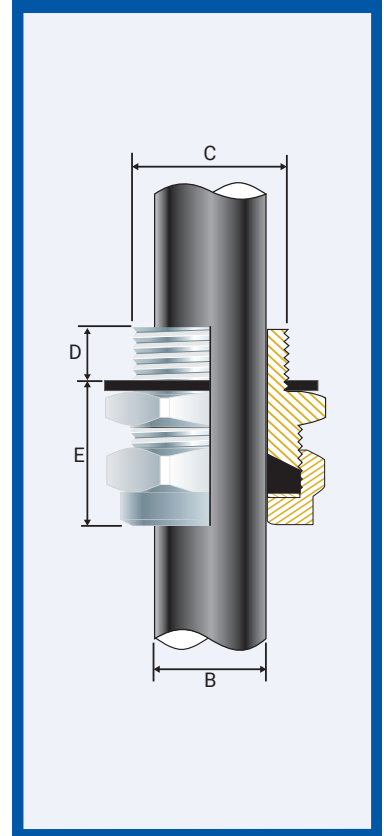

Installation Standards

- AS/NZS 3000
- BS 6121-5
- BS 7671
- BS 7430
- IEC 60364-5-54
- SANS 0142

Product Code	Gland Size Reference	Metric Entry Thread		NPT Entry Thread		Cable Detail		Maximum Length 'E'	Hexagonal Detail		Installation Torque Value Nm
		'C'	Min 'D'	'C'	Min 'D'	Min 'B'	Max 'B'		Max 'Flats'	Max 'Corns'	
053500-16S*	00-16S	M16x1.5	10	-	-	1.0	6.0	20.0	◆▲ 18.0	◆ 20.0	20.0
053500-16*	00-16ss	M16x1.5	10	-	-	3.0	8.5	20.0	◆▲ 24.0	◆ 27.0	32.5
053500*	00-20ss	M20x1.5	10	1/2/3/4	15	3.0	8.5	20.0	◆▲ 24.0	◆ 27.0	32.5
0535-0*	0-20s	M20x1.5	10	1/2/3/4	15	7.0	11.5	20.0	◆▲ 24.0	◆ 27.0	32.5
053501	1-20	M20x1.5	10	1/2/3/4	15	11.0	15.0	24.0	▲ 27.0	30.0	32.5
053522	2s-25s	M25x1.5	10	3/4/1	15/19	11.5	17.5	25.0	▲ 35.0	39.0	47.5
053502	2-25	M25x1.5	10	3/4/1	15/19	15.0	20.0	25.0	▲ 35.0	39.0	47.5
053533	3s-32s	M32x1.5	10	1/1 1/4	19	16.0	22.0	30.0	▲ 42.0	47.0	55.0
053503	3-32	M32x1.5	10	1/1 1/4	19	20.0	26.5	30.0	▲ 42.0	47.0	55.0
053544	4s-40s	M40x1.5	15	1 1/4/1 1/2	19/21	22.0	31.5	30.0	▲ 52.0	59.0	65.0
053504	4-40	M40x1.5	15	1 1/4/1 1/2	19/21	26.0	34.0	30.0	▲ 52.0	59.0	65.0
053555	5s-50s	M50x1.5	15	1 1/2/2	21	29.0	38.0	42.0	▲ 65.0	73.0	82.5
053505	5-50	M50x1.5	15	1 1/2/2	21	34.0	44.5	42.0	▲ 65.0	73.0	82.5
053566	6s-63s	M63x1.5	15	2/2 1/2	21	38.0	50.0	48.0	◆ 80.0	90.0	97.5
053506	6-63	M63x1.5	15	2/2 1/2	30	44.5	56.5	48.0	◆ 80.0	90.0	97.5
053577	7s-75s	M75x1.5	15	2 1/2/3	30	50.0	62.0	50.0	◆ 96.0	108.0	115.0
053507	7-75	M75x1.5	15	2 1/2/3	32	56.0	67.5	50.0	◆ 96.0	108.0	115.0
053588	8s-80s	M80x2.0	20	3	32	54.0	69.0	55.0	◆ 96.0	108.0	120.0
053508	8-80	M80x2.0	20	3/3 1/2	32	65.0	74.0	55.0	◆ 96.0	108.0	120.0
053599	9s-90s	M90x2.0	20	3/3 1/2	32	60.0	75.0	60.0	◆ 111.0	125.0	120.0
053509	9-90	M90x2.0	20	3/3 1/2	33	73.0	81.5	60.0	◆ 111.0	125.0	120.0
053510	10-100	M100x2.0	20	3 1/2/4	33/34	81.0	91.0	74.0	-	-	120.0
053511	11-110	M110x2.0	20	4	34	91.0	101.0	92.5	-	-	175.0
053512	12-120	M120x2.0	20	-	-	101.0	109.0	92.5	-	-	175.0
053513	13-130	M130x2.0	20	-	-	109.0	119.0	92.5	-	-	175.0

All dimensions except NPT are in mm. ▲ For use with a CCG Hex Spanner ◆ For use with a CCG C Spanner.
 ◆ When manufactured in Aluminium, Hex will be 27 Across Flats and 30 Across Corners.

A2 COMPRESSION GLAND

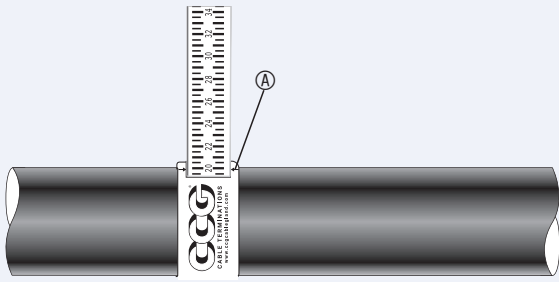

1. For accurate sizing, use a CCG Dimension Tape (A) on the outer cable sheath.

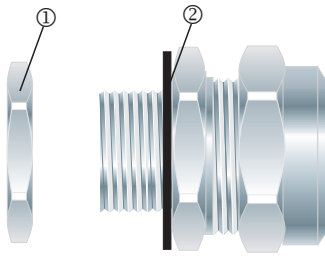

2. To maintain IP66/68, ensure the gasket (2) is in place. Remove the locknut (1).

If the gland has NPT entry threads fitted to a threaded entry then IP68 (2m) can be achieved by applying one of the following tested and approved grease types to the thread:- Renolit Lubrene CA700 or LX220 EP2, Renolit LC-WP2 or Moly LX2, or Dow Corning 4 Electrical Compound.

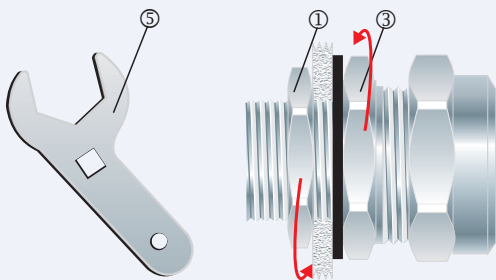

3. Screw the inner (3) into the apparatus and tighten to the installation torque using a CCG Spanner (5). Tighten the locknut (1).

Alternative installation through an unthreaded entry.

If the apparatus is untapped use a locknut.

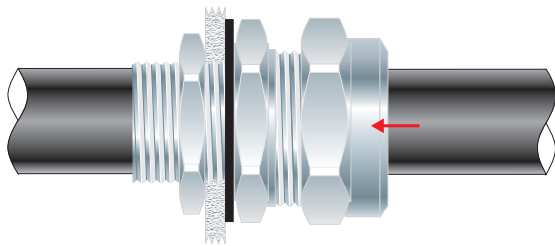
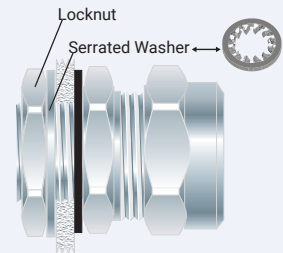

4. Pass the cable end through the gland assembly.

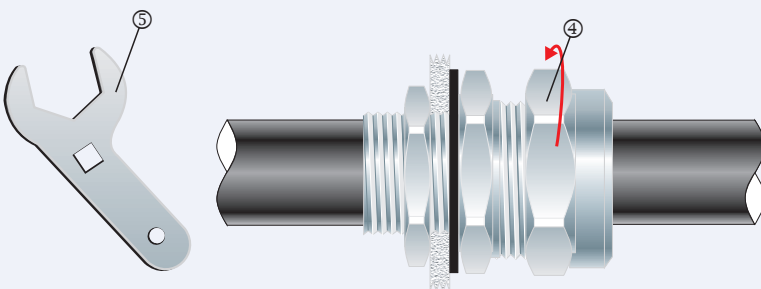

5. Tighten the outer (4) to the installation torque using a CCG Spanner (5).