

POSI FLEX™

COMPRESSION GLAND

for Unarmoured Cable

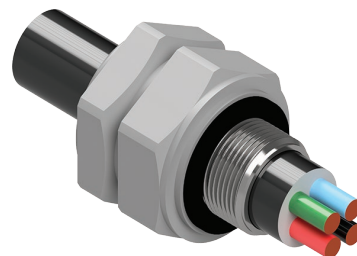

Features and Benefits

- For use in highly corrosive areas.
- Seals the cable sheath to IP66/68.
- Specially formulated elastomeric seals.
- Brass parts are encapsulated in a corrosion-resistant body.
- Precision manufactured from high-quality brass (Marine Grade Electroless Nickel Plated™).
- Supplied with a thread-sealing gasket.



Technical Data

Type:	Posi Flex™
Gland Material:	Brass (Nickel Plated) encapsulated in Nylon or DMC
Sealing Material:	Thermoset Elastomer (Standard)
Cable Type:	Unarmoured
Sealing Area:	Outer Sheath
Accessories:	Posi Spanner, Adaptor, Reducer and Serrated Washer

Standards and Certifications

Mechanical Properties:	Impact Category 7 Anchorage Type B	
Continuous Operating Temp:	-65°C to +120°C	
Conformance:	Standard:	Certification:
Design Standards	BS 6121:Part 1 EN 50262 IEC/BS EN 62444 SANS 62444 SANS 1213	CML 14CA364 CML 14CA364 CML 14CA364 MASC 22-9012 MASC 18-2047, SANS 2109/4596
IP66/68 100m - Parallel	IEC 60529	CML 15Y728, MASC 22-9015
Corrosion Protection	ASTM B117-11, BS EN ISO 3231	EXOVA N968667
Marine ABS	IEC 62444	ABS 20-SG1952694-PDA
DNV	IEC 60529, BS 6121, IEC 62444	TAE000000Z
London Underground Approval	BS EN 62444	LU 3043

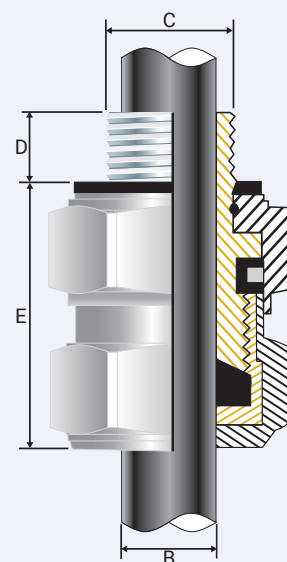

Installation Standards

- AS/NZS 3000
- BS 6121-5
- BS 7671
- BS 7430
- IEC 60364-5-54
- SANS 0142

Product Code	Gland Size Reference	Metric Entry Thread		Cable Detail		Maximum Length 'E'	Hexagonal Detail		*Installation Torque Value Nm
		'C'	Min 'D'	Min 'B'	Max 'B'		Max 'Flats'	Max 'Crns'	
053800	00-20ss	M20x1.5	10	3.0	8.0	33.0	30.0	34.0	13.5
0538-0	0-20s	M20x1.5	10	7.0	11.5	33.0	30.0	34.0	13.5
053801	1-20	M20x1.5	10	11.0	15.0	37.0	34.0	38.0	13.5
053802	2-25	M25x1.5	10	15.0	20.0	40.0	42.0	47.0	20.0
053803	3-32	M32x1.5	10	20.0	26.5	50.0	52.0	59.0	27.0
053804	4-40	M40x1.5	15	26.0	34.0	57.0	62.0	70.0	33.5

All dimensions are in mm. For sizes larger than 4-40 use CCG Posi Grip Cable Glands.

* Only CCG Posi Spanner to be used for installation torque.

POSI FLEX™ COMPRESSION GLAND

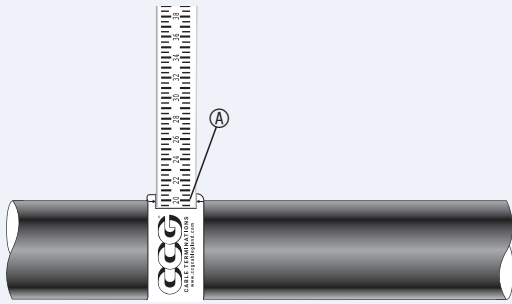

1. For accurate sizing, use a CCG Dimension Tape (A) on the outer cable sheath.

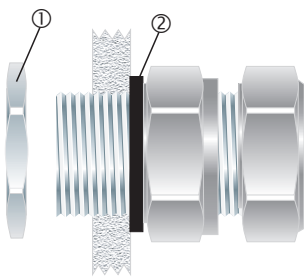

2. Remove locknut (1). To maintain IP66/68 ensure the gasket (2) is in place.

Alternative installation through an unthreaded entry.

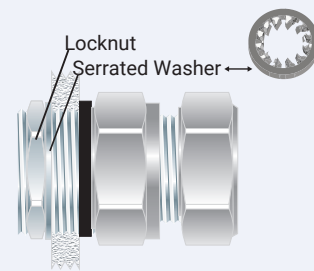

If the apparatus is untapped use a locknut.

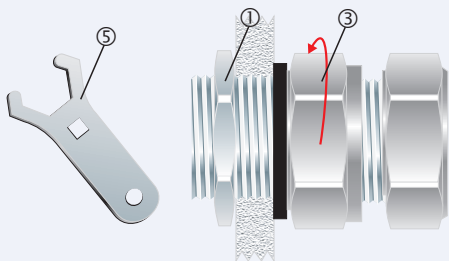

3. Screw the gland unit into apparatus. Tighten the nipple nut (3) to the installation torque value using a CCG Spanner (5). If the apparatus is untapped use a locknut (1).

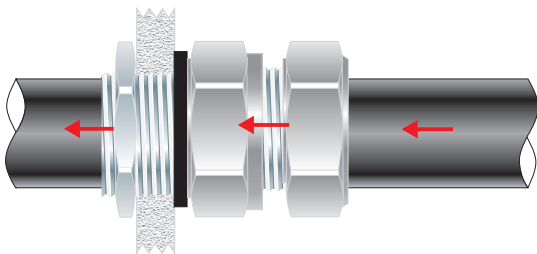

4. Pass the cable end through gland assembly.

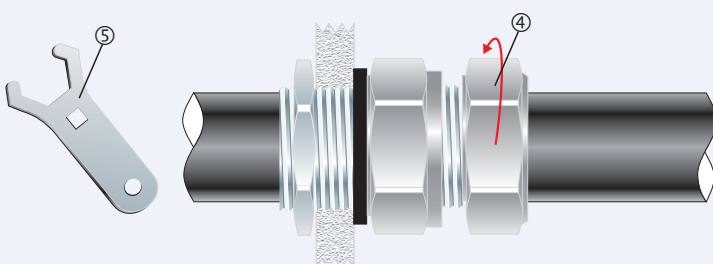

5. Tighten the outer (4) to installation torque value using a CCG Spanner (5) to produce a seal and grip on the cable.
* Only CCG Posi Spanner to be used for installation torque.