



A2F

Ex db I/IIC, Ex eb I/IIC, Ex ta IIIC, Ex nR IIC

COMPRESSION GLAND for Unarmoured Cable

Features and Benefits

- Passes the IECEx / UKEX / ATEX 100% pull test, so no additional cable clamping is required.
- For indoor, outdoor, Group I, II, III, Zone 1, 2, 20, 21 and 22 hazardous areas.
- Fitted with a specially formulated elastomeric displacement seal, giving superior cable retention, explosion protection and IP rating.
- Precision manufactured from high-quality brass (Marine Grade Electroless Nickel Plated™) available in aluminium or stainless steel 316/316L on request. (Note: Aluminium is not suitable for Group I applications.)
- Supplied with a thread sealing gasket (parallel threads only).



Technical Data

Type:	A2F
Gland Material:	Brass (Marine Grade Electroless Nickel Plated™), Aluminium or Stainless Steel 316/316L
Seal Material:	Standard Thermoset Elastomer or Extreme Temperature Seals
Sealing Gasket Material:	HDPE, Nylon 66 or PTFE
Cable Type:	Unarmoured
Sealing Area:	Outer Sheath
Optional Accessories:	Adaptor, Reducer, Earth Tag, Locknut, Serrated Washer and Shroud
Note:	The installer should ensure that the materials are suitable for the installation environment.

Standards and Certifications

Equipment Protection Levels:	IECEx/INMETRO: Ex db eb I Mb, Ex db eb IIC Gb, Ex nR IIC Gc, Ex ta IIIC Da ATEX/UKEX: Ⓜ I M2, Ⓜ II 2/3 G, Ex db eb I Mb, Ex db eb IIC Gb, Ex nR IIC Gc, Ex ta IIIC Da TR CU: Ⓜ 1Ex d IIC Gb X / 1Ex e IIC Gb X / 2Ex nR IIC Gc X / Ex tb IIIC Db X CCC: Ex db IIC Gb, Ex eb IIC Gb, Ex ta IIIC Da	
Continuous Operating Temp:	Standard Seals: -60°C to +95°C / 100°C (HDPE/ Nylon Sealing Gasket) Extreme Temp. Seals: -60°C to +160°C (PTFE Sealing Gasket)	
Conformance:	Standard:	Certificate:
IEC/BS EN	IEC/BS EN 62444	CML 14CA364
IECEX	IEC 60079 Part 0, 1, 7, 15, 31	IECEX MSC 20.0002
ATEX	EN 60079 Part 0, 1, 7, 31 EN 60079 Part 0, 15	CML 20ATEX1026 CML 22ATEX4116
UKEX	BS EN 60079 Part 0, 1, 7, 31 BS EN 60079 Part 0, 15	CML 21UKEX1013 CML 22UKEX4117
INMETRO (Brazil)	ABNT NBR IEC 60079 Part 0, 1, 7, 15, 31	TUV 15.0483X
TR CU (Russia)	ГОСТ 31610-0, 15, ГОСТ IEC 60079-1 ГОСТ P MЭК 60079-7, 31	EAЭC RU C-ZA.HA91.B.00245/21
CCC/CNEx (Chinese)	GB/T3836.1, 2, 3, 31-2021	CNEx 21.3389X CCC 2021312313000392
KCs (Korea)	Notification of Ministry of Labour No.2013-54	16-AV4BO-0282-5X
SANS	SANS/IEC 60079 Part 0, 1, 7, 15, 31	MASC MS/22-9001X CML 15Y728
IP66/68 850m – Parallel	IEC 60529	
IP65/66 – Tapered	IEC 60529	
IP68 – Tapered and approved grease Deluge Protection	IEC 60529 DTS-01	IECEX CML 18.0018X CML 14CA370-2
Corrosion Protection	ASTM B117-11, BS EN ISO 3231	EXOVA N968667
Marine ABS	IEC/EN 60079 Part 0, 1, 7, 15, 31	ABS 20-1952706-1-PDA
DNV-GL	IEC/EN 60079 Part 0, 1, 7, 15, 31	DNV-GL TAE0000010
ClassNK	IEC 60079 Part 0, 1, 7, 15, 31	TA20269M
EMC Compatible	EN 55011, + A1, EN 55022	SGS EMC305079/1

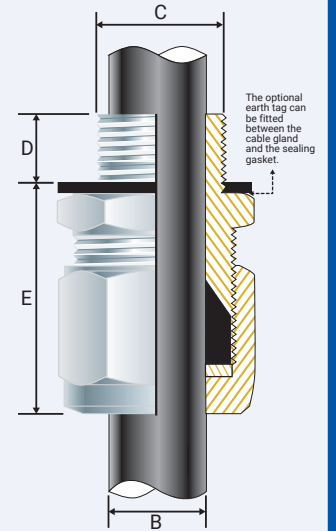

Conditions for Safe Use - X

- None.
- Note: According to IEC 60079-14, 10.6.2: An Ex d gland will only maintain Ex d integrity when used with substantially round, compact and filled cable. If not a CCG VORTEX® barrier gland should be used.

Product Code	Gland Size Reference	Metric Entry Thread		NPT Entry Thread		Cable Detail		Maximum Length 'E'	Hexagonal Detail		Installation Torque Value Nm
		'C'	Min 'D'	'C'	Min 'D'	Min 'B'	Max 'B'		Max 'Flats'	Max 'Crns'	
054100-16S	00-16S	M16x1.5	15	-	-	1.0	4.0	25.0	24.0	27.0	32.5
054100-16	00-16ss	M16x1.5	15	-	-	3.0	8.5	25.0	24.0	27.0	32.5
054100	00-20ss	M20x1.5	15	1/2/3/4	15	3.0	8.5	25.0	24.0	27.0	32.5
0541-0	0-20s	M20x1.5	15	1/2/3/4	15	7.0	12.0	25.0	24.0	27.0	32.5
054101	1-20	M20x1.5	15	1/2/3/4	15	11.0	15.0	30.0	27.0	30.0	32.5
054122	2s-25s	M25x1.5	15	3/4/1	15/19	11.5	17.5	30.0	35.0	39.0	47.5
054102	2-25	M25x1.5	15	3/4/1	15/19	15.0	20.0	30.0	35.0	39.0	47.5
054133	3s-32s	M32x1.5	15	1/1 1/4	19	16.0	22.0	30.0	42.0	47.0	55.0
054103	3-32	M32x1.5	15	1/1 1/4	19	20.0	26.5	30.0	42.0	47.0	55.0
054144	4s-40s	M40x1.5	15	1 1/4/1 1/2	19/21	22.0	31.5	38.0	52.0	59.0	65.0
054104	4-40	M40x1.5	15	1 1/4/1 1/2	19/21	26.0	34.0	38.0	52.0	59.0	65.0
054155	5s-50s	M50x1.5	15	1 1/2/2	21	29.0	38.0	46.0	65.0	73.0	82.5
054105	5-50	M50x1.5	15	1 1/2/2	21	34.0	44.5	46.0	65.0	73.0	82.5
054166	6s-63s	M63x1.5	15	2/2 1/2	21/30	38.0	50.0	52.0	80.0	90.0	97.5
054106	6-63	M63x1.5	15	2/2 1/2	21/30	44.5	56.5	52.0	80.0	90.0	97.5
054177	7s-75s	M75x1.5	15	2 1/2/3	30/32	50.0	62.0	54.0	96.0	108.0	115.5
054107	7-75	M75x1.5	15	2 1/2/3	30/32	56.0	67.5	54.0	96.0	108.0	115.5
054108	8-80	M80x2.0	20	3	32	54.0	69.0	68.0	96.0	108.0	120.0
054199	9s-90s	M90x2.0	20	3/3 1/2	32/33	60.0	75.0	70.0	111.0	125.0	120.0
054109	9-90	M90x2.0	20	3/3 1/2	32/33	73.0	81.5	70.0	111.0	125.0	120.0
054110	10-100	M100x2.0	20	3 1/2/4	33/34	81.0	92.0	70.0	125.0	141.0	120.0
054111	11-110	M110x2.0	20	4	34	91.0	101.0	70.0	135.0	152.0	175.0
054112	12-120	M120x2.0	20	-	-	101.0	109.0	70.0	140.0	158.0	175.0
054113	13-130	M130x2.0	20	-	-	109.0	116.0	70.0	146.0	164.0	175.0

All dimensions except NPT are in mm. Intermediate thread sizes are available on request. NPT threads should be tightened 'wrench tight'

CCG reserves the right to make alterations to the technical data, dimensions, designs and products available without notice. The illustrations cannot be considered binding. Please contact CCG for assistance.

A2F-GH030523E

A2F COMPRESSION GLAND

ENCLOSURES AND EQUIPMENT TO WHICH CABLE GLANDS ARE FITTED:-

- Must be made from materials which are compatible with the cable gland materials.
- Have a sealing area around the cable gland entry point with a surface roughness <math>< Ra 6.3 \mu m</math>.
- Have entries that are perpendicular to the enclosure face in the area where the cable gland will seal to within 2.5°.
- Are sealed using the supplied sealing gasket (parallel threads) or by fully tightening into a threaded entry (tapered threads). Note that for tapered threads the IP rating can be improved to IP68 with the use of a suitable thread sealant.

MUST HAVE THREADED ENTRIES

- The same thread size as the cable gland. (Thread adapters should be used to correct

any mismatch).

- With a thread tolerance of metric class '6H' or equivalent.
- Where the thread length is a minimum of 10mm for Ex d applications or 3mm for all other applications

OR CLEARANCE HOLES (not Ex d)

- Where the hole size is the thread nominal size with a tolerance of +0.1 to +0.7mm. (e.g. the clearance hole for an M20 thread will have a diameter between 20.1mm and 20.7mm).
- Through material that is between 1mm and 12mm thick. (Thicker materials can be accommodated using glands with extended entry threads.)

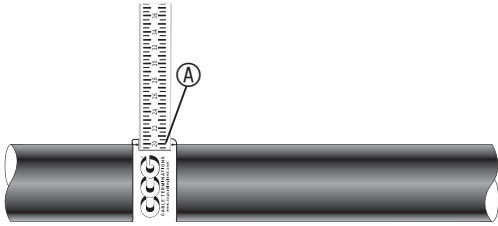

1. For accurate sizing, use a CCG Dimension Tape (A) on the outer cable sheath.

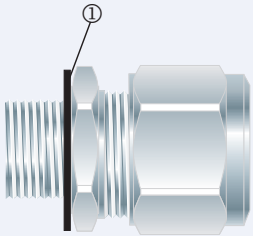

2. To maintain IP66/68, ensure the gasket (1) is in place.

If the gland has NPT entry threads fitted to a threaded entry then IP68 (2m) can be achieved by applying one of the following tested and approved grease types to the thread:- Renolit Lubrene CA700 or LX220 EP2, Renolit LC-WP2 or Moly LX2, or Dow Corning 4 Electrical Compound.

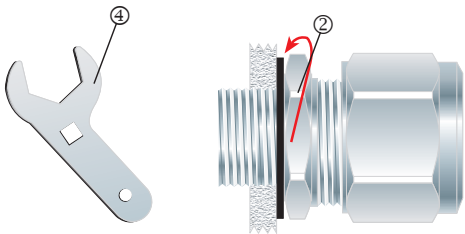

3. Screw the inner (2) into the apparatus. Tighten the inner (2) to the installation torque using a CCG Spanner (4).

Alternative installation through an unthreaded entry.

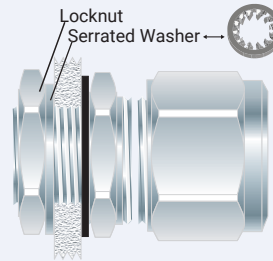

If the apparatus is unthreaded use a locknut.

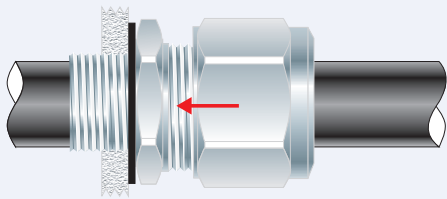

4. Pass the cable end through the gland assembly.

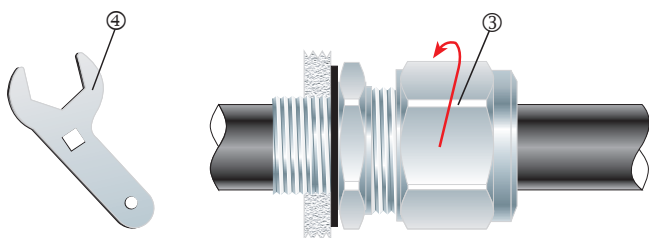

5. Tighten the outer nut (3) to the installation torque using a CCG Spanner (4) to produce a seal and grip on the cable.