

CW LSOH

CAPTIVE COMPONENT GLAND®



for Steel Wire Armoured and Aluminium Armoured Fire Rated Cable

Features and Benefits

- For indoor and outdoor use. Two-piece handling, no loose parts.
- Freely rotating captive cone and inspectible cone ring, providing an armour clamp and earth bond without twisting the armouring.
- Patented disconnect armour clamp system for ease of inspection.
- Provides a seal on the outer sheath of the cable sealing to IP65/66.
- Precision manufactured from high-quality brass (nickel plated), available in aluminium or stainless steel 316/316L on request.
- Silicon seals are fire-retardant, low smoke zero halogen and suitable for extreme temperatures.
- Complete with a fire-retardant, low smoke zero-halogen, extreme temperature thread-sealing gasket.
- Complete with a heavy-duty locknut.



Technical Data

Type:	CW LSOH
Gland Material:	Brass (Nickel Plated) BS 2874, EN 12164, Aluminium ASTM BS221 or Stainless Steel 316/316L
Seal Material:	LSOH Silicon
Cable Type:	Steel Wire Armour, Aluminium Armour Wire Fire Rated
Armour Clamping:	Rotating Captive Cone and Inspectible Cone Ring
Sealing Area:	Outer Sheath
Optional Accessories:	Adaptor, Reducer, Earth Tag, Locknut, Serrated Washer and Shroud

Standards and Certifications

Mechanical Properties:	Impact Category 8 Anchorage Type D	
Electrical Properties:	Category A (no earth tag) Category B (with earth tag)	
Continuous Operating Temp:	-65°C to +175°C	
Conformance:	Standard:	Certificate:
Design Standards	BS 6121:Part 1 EN 50262 IEC/BS EN 62444 SANS 62444 SANS 1213 IEC 60529	CML 14CA364 CML 14CA364 CML 14CA364 MASC 22-9012 MASC 18-2047, SANS 2109/4596 MASC 22-9015
IP66 - Parallel	IEC 60529	
IP65 - Tapered	IEC 60529	
Marine ABS	IEC 62444	ABS 20-SG1952694-PDA
DNV-GL	IEC 60529, BS 6121, IEC 62444	DNV-GL TAE000000Z
EMC Compatible	EN 55011, + A1, EN 55022	SGS EMC305079/1
Halogen Free	NAC259	TDWR 14-04-13
Flame Retardant	ASTM D 2863-09, ISO 4589-2	TDWR 14-04-13
Low Smoke	BS EN61034-2, BS6853	CSIR 24580f
London Underground Approval	BS EN 62444	LU 3043

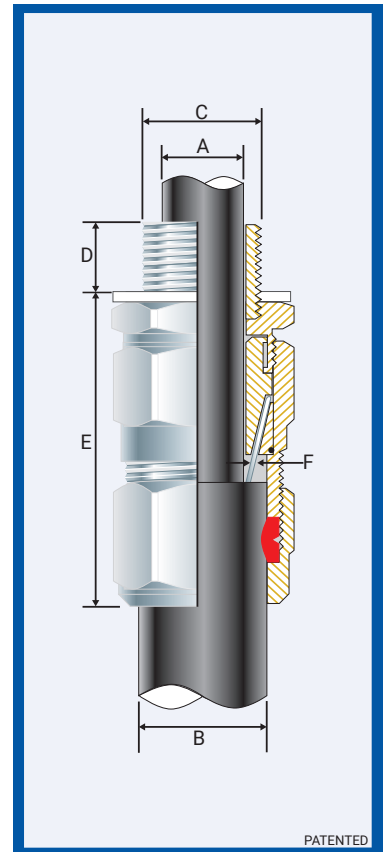

Installation Standards

- AS/NZS 3000
- BS 6121-5
- BS 7671
- BS 7430
- IEC 60364-5-54
- SANS 0142

Product Code	Gland Size Reference	Metric Entry Thread		NPT Entry Thread		Cable Detail			Max Length 'E'	Armour Dia		Hexagonal Detail		Install Torque Value Nm	
		'C'	Min 'D'	'C'	Min 'D'	Max 'A'	Min 'B'	Max 'B'		Min 'F'	Max 'F'	Max 'Flats'	Max 'Crms'		
055300-16	◆ 00-16ss	M16x1.5	10	-	-	8.5	8.0	13.5	41.0	0.90	0.90	◆ 24.0	◆ 27.0	35.0	
055300	◆ 00-20ss	M20x1.5	10	1/2	3/4	15	8.5	8.0	13.5	41.0	0.90	0.90	◆ 24.0	◆ 27.0	35.0
0553-0	◆ 0-20s	M20x1.5	10	1/2	3/4	15	12.0	11.5	16.0	43.0	0.90	1.25	◆ 24.0	◆ 27.0	35.0
055301	1-20	M20x1.5	10	1/2	3/4	15	15.0	14.5	20.5	47.0	0.90	1.25	27.0	30.0	35.0
055322	2s-25s	M25x1.5	10	3/4	1	15/19	17.5	16.0	24.5	56.0	1.25	1.60	35.0	39.0	50.0
055302	2-25	M25x1.5	10	3/4	1	15/19	20.0	20.5	26.5	56.0	1.25	1.60	35.0	39.0	50.0
055333	3s-32s	M32x1.5	10	1 1/4	1 1/2	19	22.0	23.0	30.5	57.0	1.60	2.00	42.0	47.0	70.0
055303	3-32	M32x1.5	10	1 1/4	1 1/2	19	26.5	26.5	33.5	57.0	1.60	2.00	42.0	47.0	70.0
055344	4s-40s	M40x1.5	15	1 1/4	1 1/2	19/21	31.5	30.0	39.5	68.0	1.60	2.00	52.0	59.0	90.0
055304	4-40	M40x1.5	15	1 1/4	1 1/2	19/21	34.0	33.0	42.5	68.0	1.60	2.00	52.0	59.0	90.0
055355	5s-50s	M50x1.5	15	1 1/2	2	21	38.0	34.0	47.5	72.0	2.00	2.50	65.0	73.0	100.0
055305	5-50	M50x1.5	15	1 1/2	2	21	38.0/44.5	42.5	52.5	72.0	2.00	2.50	65.0	73.0	100.0
055366	6s-63s	M63x1.5	15	2 1/2	2 1/2	21/30	50.0	45.5	60.5	89.0	2.00	2.50	80.0	90.0	120.0
055306	6-63	M63x1.5	15	2 1/2	2 1/2	21/30	50.0/56.5	52.5	65.5	89.0	2.00	2.50	80.0	90.0	120.0
055377	7s-75s	M75x1.5	15	2 1/2	3	30/32	62.0	57.0	72.5	97.0	2.50	3.15	96.0	108.0	120.0
055307	7-75	M75x1.5	15	2 1/2	3	30/32	62.0/67.5	65.5	78.0	97.0	2.50	3.15	96.0	108.0	120.0
055388	8s-80s	M80x2.0	20	3	3	32	69.0	65.0	77.5	98.0	2.50	3.15	96.0	108.0	120.0
055308	8-80	M80x2.0	20	3	3	32	74.0	78.0	82.0	98.0	2.50	3.15	96.0	108.0	120.0
055399	9s-90s	M90x2.0	20	3 3/4	3 3/4	32/33	75.0	73.0	86.5	123.0	3.00	3.50	96.0	108.0	120.0
055309	9-90	M90x2.0	20	3 3/4	3 3/4	32/33	75.0/81.5	82.0	91.0	123.0	3.00	3.50	-	-	120.0
055310	10-100	M100x2.0	20	3 1/2	4	33/34	91.0	90.0	100.0	124.0	3.00	3.50	-	-	120.0
055311	11-110	M115x2.0	20	4	4	34	98.0	100.0	114.0	134.0	3.00	4.00	-	-	120.0
055312	12-120	M120x2.0	20	-	-	-	103.0	103.0	118.0	136.0	3.00	4.00	-	-	120.0
055313	13-130	M130x2.0	20	-	-	-	115.0	113.0	124.0	140.0	3.00	4.00	-	-	120.0

All dimensions except NPT are in mm. ◆ Supplied with fixed cone and bush.

◆ When manufactured in Aluminium, Hex will be 27 Across Flats and 30 Across Corners.

CW LSOH CAPTIVE COMPONENT GLAND®

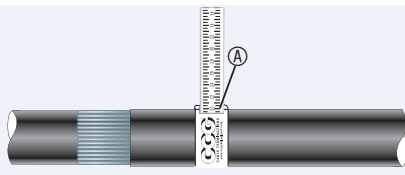

1. For accurate sizing, use a CCG Dimension Tape (A) on the inner and outer cable sheath.

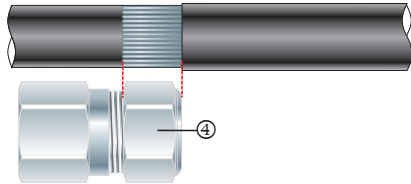

2. Cut back the cable outer sheath to expose the armour to a length not more than the outer nut (4).

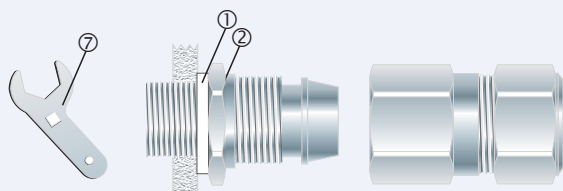

3. To maintain IP66, ensure the gasket (1) is in place. Screw inner (2) into the apparatus. Tighten inner (2) to the installation torque using a CCG Spanner (7). If apparatus is untapped, use a locknut.

Alternative installation through an unthreaded entry.

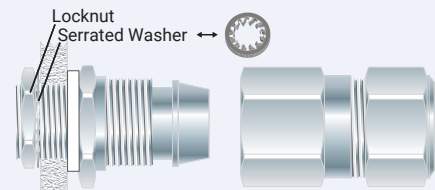

If the apparatus is untapped use a locknut.

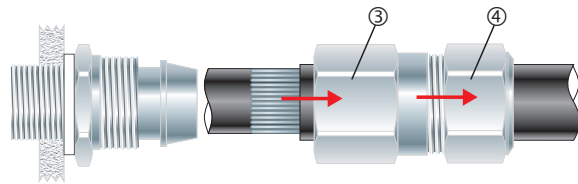

4. Pass the outer nut (4) and the body (3) over the cable.

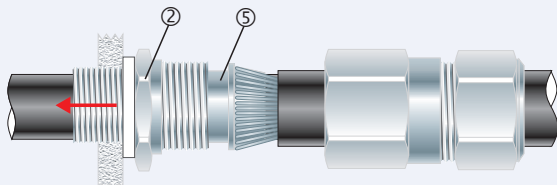

5. Pass cable end through the inner (2). Splay the armour wires over the cone (5).

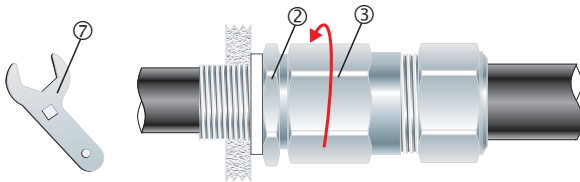

6. Tighten the body (3) onto the inner (2) until hand tight, then tighten with a CCG Spanner (7) with 3/4 turn to lock the armour between the cone (5) and the cone ring (6).

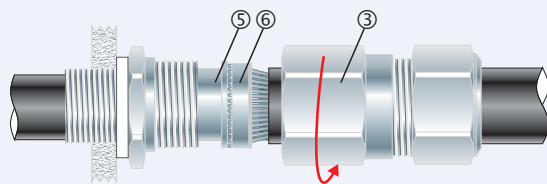

7. Unscrew the body (3). Check that the armour has locked between the cone (5) and the cone ring (6). (O-Ring on the cone ring (6) is sacrificial.)

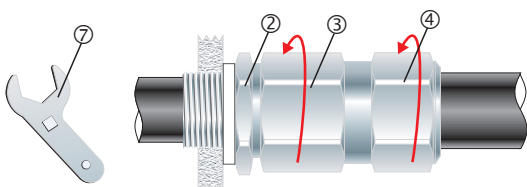

8. Tighten the body (3) onto the inner (2) to the installation torque using a CCG Spanner (7). Tighten the outer nut (4) to produce a moisture proof seal by turning until the seal makes contact with outer sheath of cable and then make one full turn.