



# E1W INSULATED CAPTIVE COMPONENT GLAND®

for Steel Wire and Aluminium Armoured Cable

## Features and Benefits

- For indoor and outdoor use.
- Gland is insulated from equipment to prevent system circulating currents.
- Freely rotating captive cone and inspectible cone ring, providing an inspectible armour clamp and earth bond without twisting the armouring.
- Patented disconnect armoured clamp system for ease of inspection
- Provides a seal on the inner and outer sheath of the cable, sealing to IP66.
- Precision manufactured from high-quality brass (nickel plated), available in aluminium or stainless steel 316/316L on request.
- Supplied with a thread-sealing gasket and a heavy-duty (nickel-plated) locknut.



## Technical Data

Type:	E1W Insulated
Gland Material:	Brass (Nickel Plated), BS 2874, EN 12164, Aluminium ASTM BS221, Stainless Steel 316/316L
Seal Material:	Thermoset Elastomer or Silicone on request
Cable Type:	Steel Wire Armour and Aluminium Armour Wire
Armour Clamping:	Rotating Captive Cone and Inspectible Cone Ring
Sealing Area:	Inner Sheath and Outer Sheath
Optional Accessories:	Adaptor, Reducer, Earth Tag, Locknut, Serrated Washer and Shroud

## Standards and Certification

Mechanical Properties:	Impact Category 8	Anchorage Type D
Continuous Operating Temp:	-65°C to +120°C	
Conformance:	Standard:	Certificate:
Design Standards	BS 6121:Part 1 IEC/BS EN 62444 SANS 62444 SANS 1213	CML 14CA364 CML 14CA364 MASC 22-9012 MASC 18-2047, SANS 2109/4596
IP66 - Parallel	IEC 60529	MASC 22-9015
Marine ABS	IEC 62444	ABS 20-SG1952694-PDA
DNV-GL	IEC 60529, BS 6121, IEC 62444	DNV-GL TAE000000Z
EMC Compatible	EN 55011, + A1, EN 55022	SGS EMC305079/1
London Underground Approval	BS EN 62444	LU 3044

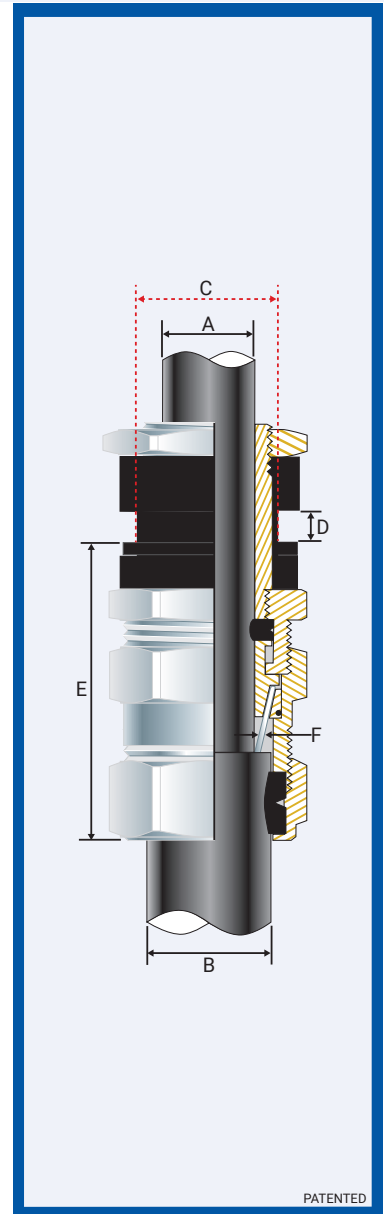

## Installation Standards

- AS/NZS 3000
- BS 6121-5
- BS 7671
- BS 7430
- IEC 60364-5-54
- SANS 0142

Product Code	Gland Size Ref	Metric Entry Thread		Cable Detail				Max Length 'E'	Armour Dia		Hexagonal Detail		Installation Torque Value Nm
		'C'	Max 'D'	Min 'A'	Max 'A'	Min 'B'	Max 'B'		Min 'F'	Max 'F'	Max 'Flats'	Max 'Crns'	
0558-0*	0-20s	20	10	7.0	12.0	11.5	16.0	60.0	0.90	1.25	♦ 24.0	♦ 27.0	35.0
055801	1-20	20	10	11.0	13.5	14.5	20.5	70.0	0.90	1.25	27.0	30.0	35.0
055802	2-25	25	10	14.0	17.5	20.5	26.5	80.0	1.25	1.60	35.0	39.0	50.0
055803	3-32	32	10	19.0	24.0	26.5	33.5	80.0	1.60	2.00	42.0	47.0	70.0
055804	4-40	40	10	26.0	34.0	33.0	42.5	90.0	1.60	2.00	52.0	59.0	90.0
055805	5-50	50	10	34.0	42.5	42.5	52.5	110.0	2.00	2.50	65.0	73.0	100.0
055806	6-63	63	10	44.0	55.5	52.5	65.5	135.0	2.00	2.50	80.0	90.0	120.0
055807	7-75	75	10	56.0	68.0	65.5	78.0	140.0	2.50	3.15	96.0	108.0	120.0

All dimensions are in mm.

\* When manufactured in Aluminium, Hex will be 27 Across Flats and 30 Across Corners.

CCG reserves the right to make alterations to the technical data, dimensions, designs and products available without notice. The illustrations cannot be considered binding. Please contact CCG for assistance.

E1WIN-PEG080323E

### E1W INSULATED CAPTIVE COMPONENT GLAND®

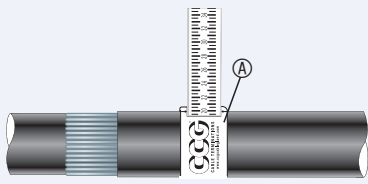

1. For accurate sizing, use a CCG Dimension Tape **(A)** on the inner and outer cable sheath.

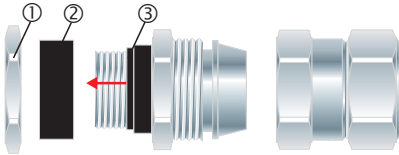

2. Remove the locknut **(1)** and the female insulator ring **(2)**. To maintain IP66/68 ensure the gasket **(3)** is in place.

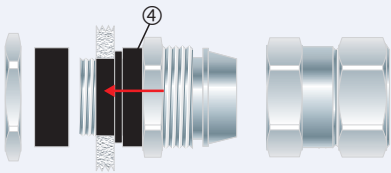

3. Insert the male insulator entry **(4)** into the cable entry of apparatus.

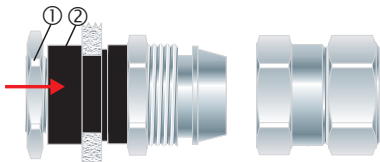

4. Screw the female insulator ring **(2)** back against the apparatus (maximum of 10mm thickness). Screw the locknut **(1)** back against the female insulator ring **(2)**.

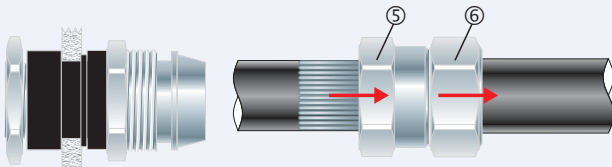

5. Pass the outer nut **(6)** and the body **(5)** over the cable.

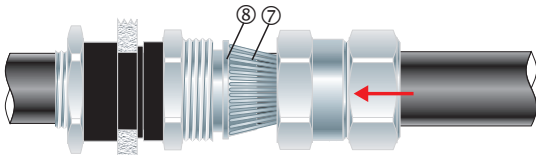

6. Pass the cable end through the inner and splay the armour wires **(7)** over cone **(8)**.

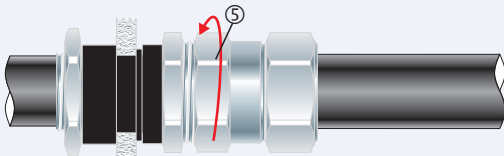

7. Screw the body **(5)** onto the inner and tighten the body **(5)** to lock the armour between the cone **(8)** and the cone ring **(9)**.

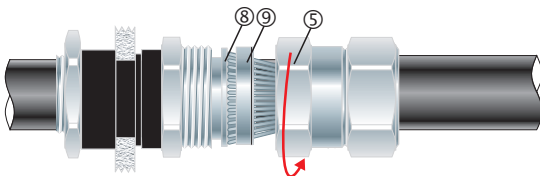

8. Unscrew the body **(5)**. Check that the armour has locked between the cone **(8)** and the cone ring **(9)**. (O-Ring on the cone ring **(9)** is sacrificial)

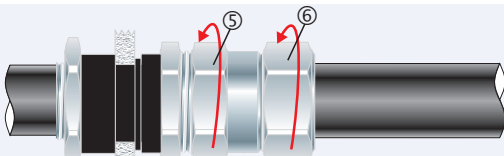

9. Tighten the body **(5)** onto the inner. Tighten the outer nut **(6)** to produce a moisture-proof seal by turning until the seal makes contact with the outer sheath of cable and make one full turn.