



# A2EX

## DOUBLE SEAL COMPRESSION GLAND for Unarmoured Tray Cable

### Features and Benefits

- Gland for use in Ordinary and Hazardous Locations.
- Inner seal seals on the cable sheath.
- Harder outer seal grips the cable giving superior cable retention and IP rating.
- Precision manufactured from high-quality brass (Marine Grade Electroless Nickel Plated™) available in stainless steel 316/316L on request.
- Complete with a thread sealing gasket.



### Technical Data

Type:	A2EX
Gland Material:	Brass (Marine Grade Electroless Nickel Plated™), Stainless Steel 316/316L
Seal Material:	Standard Thermoset Elastomer or Extreme Temperature Seals
Sealing Gasket Material:	HDPE, Nylon 66 or PTFE
Cable Type:	Unarmoured Tray Cable
Sealing Area:	Outer Sheath
Optional Accessories:	Adaptor, Reducer, Earth Tag, Locknut, Serrated Washer and Shroud
Note:	The installer should ensure that the materials are suitable for the installation environment.

### Temperature Range

When fitted with sealing gaskets the temperature range for the gland will be:-

Sealing Gasket Material:	Standard Seals: -60°C and +95°C/100°C (HDPE/Nylon Sealing Gasket)
	Extreme Temp. Seals: -60°C and +160°C (PTFE Sealing Gasket)

### Standards and Certifications

Equipment Protection Levels:	NEC / CEC: Class I Div 2 Gr ABCD, Class II Division 2 Gr FG, Class III Division 2 Ex db IIC Gb, Class I Zone 1 AEx eb IIC Gb / Ex eb IIC Gb Zone 21 AEx ta IIIC Da Ex ta IIIC Da, Class I Zone 2 AEx nR IIC Gc / Ex nR IIC Gc, IP66/67/68, IP65, Type 4	
	IECEx: Ex db IIC Gb, Ex eb IIC Gb, Ex nR IIC Gc, Ex ta IIIC Da	
Conformance:	Standard:	Certificate:
CEC	CSA C22.2 No. 18.3-12, 174:2018 & 213:2017 CSA C22.2 No. 60079 - 0, 1, 7, 15, 31	E115594
NEC	UL514B, UL121201 UL 60079: 0, 7, 15, 31	
IECEx	IEC 60079 - 0, 1, 7, 15, 31	IECEx CML 18.0018X
IP66/68 100m - Parallel	IEC 60529	CML 15Y728
IP68 – Tapered and approved grease	IEC 60529	IECEx CML 18.0018X
Nema Type 4X	NEMA 250	E115594
Deluge Protection	DTS-01	CML 14CA370-2
Corrosion Protection	ASTM B117-11, BS EN ISO 3231	EXOVA N968667
Marine ABS	IEC 60079 - 0, 1, 7, 15, 31 and IEC 60529	ABS 20-SG1952706-PDA
DNV-GL	IEC/EN 60079 - 0, 1, 7, 15, 31	DNV-GL TAE0000010

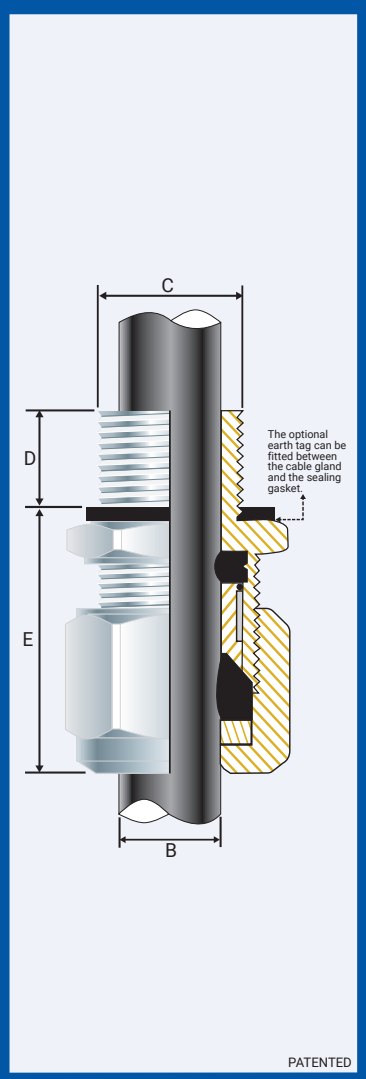

### Conditions for Safe Use - X

- The cable gland sizes under M20 / ¾" NPT shall only be used on fixed installations where the cable is clamped, or stress applied to the cable gland is prevented.
- According to IEC 60079-14, 10.6.2: An Ex d gland will only maintain Ex d integrity when used with substantially round, compact and filled cable. If not a CCG VORTEX® barrier gland should be used.

### NPT Entry Thread

Gland Size Ref	Product Code	NPT Entry Thread		Alternative Thread Product Code	NPT Entry Thread		Cable Detail		Maximum Length 'E'	Hexagonal Detail	
		'C'	Min 'D'		'C'	Min 'D'	Min 'B'	Max 'B'		Max 'Flats'	Max 'Crms'
00-20ss	053600-012NPT-MNA	½"	0.590	053600-034NPT-MNA	¾"	0.590	0.118	0.335	0.984	0.945	1.063
0-20s	0536-0-012NPT-MNA	½"	0.590	0536-0-034NPT-MNA	¾"	0.590	0.275	0.472	0.984	0.945	1.063
1-20v	053601-012NPT-MNA	½"	0.590	053601-034NPT-MNA	¾"	0.590	0.433	0.590	1.181	1.063	1.181
2s-25s	053622-034NPT-MNA	¾"	0.590	053622-001NPT-MNA	1"	0.748	0.453	0.689	1.181	1.377	1.535
2-25	053602-034NPT-MNA	¾"	0.590	053602-001NPT-MNA	1"	0.748	0.590	0.787	1.181	1.377	1.535
3s-32s	053633-001NPT-MNA	1"	0.748	053633-114NPT-MNA	1½"	0.748	0.630	0.866	1.181	1.653	1.850
3-32	053603-001NPT-MNA	1"	0.748	053603-114NPT-MNA	1½"	0.748	0.787	1.043	1.181	1.653	1.850
4s-40s	053644-114NPT-MNA	1½"	0.748	053644-112NPT-MNA	1½"	0.826	0.866	1.240	1.495	2.046	2.322
4-40	053604-114NPT-MNA	1½"	0.748	053604-112NPT-MNA	1½"	0.826	1.023	1.338	1.495	2.046	2.322
5s-50s	053655-112NPT-MNA	1½"	0.826	053655-002NPT-MNA	2"	0.826	1.141	1.495	1.810	2.558	2.873
5-50	053605-112NPT-MNA	1½"	0.826	053605-002NPT-MNA	2"	0.826	1.338	1.751	1.810	2.558	2.873
6s-63s	053666-002NPT-MNA	2"	0.826	053666-212NPT-MNA	2½"	1.181	1.495	1.968	2.046	3.148	3.542
6-63	053606-002NPT-MNA	2"	0.826	053606-212NPT-MNA	2½"	1.181	1.751	2.224	2.046	3.148	3.542
7s-75s	053677-212NPT-MNA	2½"	1.181	053677-003NPT-MNA	3"	1.259	1.968	2.440	2.125	3.778	4.250
7-75	053607-212NPT-MNA	2½"	1.181	053607-003NPT-MNA	3"	1.259	2.204	2.656	2.125	3.778	4.250
8-80	053608-003NPT-MNA	3"	1.259	-	-	-	2.125	2.715	2.676	3.778	4.250
9s-90s	053699-003NPT-MNA	3"	1.259	053699-312NPT-MNA	3½"	1.299	2.361	2.952	2.755	4.368	4.919
9-90	053609-003NPT-MNA	3"	1.259	053609-312NPT-MNA	3½"	1.299	2.873	3.207	2.755	4.368	4.919
10-10	053610-312NPT-MNA	3½"	1.299	053610-004NPT-MNA	4"	1.338	3.188	3.621	2.755	4.919	5.549
11-110	053611-004NPT-MNA	4"	1.338	-	-	-	3.581	3.975	2.755	5.313	5.982

All dimensions are in inches. NPT threads should be tightened 'wrench tight'.

CCG reserves the right to make alterations to the technical data, dimensions, designs and products available without notice. The illustrations cannot be considered binding. Please contact CCG for assistance.

A2EX-GH250123NA

## Metric Entry Thread

Gland Size Reference	Product Code	Metric Entry Thread		Cable Detail		Maximum Length 'E'	Hexagonal Detail		Tightening Torque Nm/lb ft
		'C'	Min 'D'	Min 'B'	Max 'B'		Max 'Flats'	Max 'Crns'	
053600-MNA	00-20ss	M20x1.5	0.591	0.118	0.335	0.984	0.945	1.063	33/24
05360-MNA	0-20s	M20x1.5	0.591	0.276	0.472	0.984	0.945	1.063	33/24
053601-MNA	1-20	M20x1.5	0.591	0.433	0.591	1.181	1.063	1.181	33/24
053622-MNA	2s-25s	M25x1.5	0.591	0.453	0.689	1.181	1.378	1.535	48/35
053602-MNA	2-25	M25x1.5	0.591	0.591	0.787	1.181	1.378	1.535	48/35
053633-MNA	3s-32s	M32x1.5	0.591	0.630	0.866	1.181	1.654	1.850	55/41
053603-MNA	3-32	M32x1.5	0.591	0.787	1.043	1.181	1.654	1.850	55/41
053644-MNA	4s-40s	M40x1.5	0.591	0.866	1.240	1.496	2.047	2.323	65/48
053604-MNA	4-40	M40x1.5	0.591	1.024	1.339	1.496	2.047	2.323	65/48
053655-MNA	5s-50s	M50x1.5	0.591	1.142	1.496	1.811	2.559	2.874	83/61
053605-MNA	5-50	M50x1.5	0.591	1.339	1.752	1.811	2.559	2.874	83/61
053666-MNA	6s-63s	M63x1.5	0.591	1.496	1.969	2.047	3.150	3.543	98/72
053606-MNA	6-63	M63x1.5	0.591	1.752	2.224	2.047	3.150	3.543	98/72
053677-MNA	7s-75s	M75x1.5	0.591	1.969	2.441	2.126	3.780	4.252	116/85
053607-MNA	7-75	M75x1.5	0.591	2.205	2.657	2.126	3.780	4.252	116/85
053608-MNA	8-80	M80x2.0	0.787	2.126	2.717	2.677	3.780	4.252	120/89
053699-MNA	9s-90s	M90x2.0	0.787	2.362	2.953	2.756	4.370	4.921	120/89
053609-MNA	9-90	M90x2.0	0.787	2.874	3.209	2.756	4.370	4.921	120/89
053610-MNA	10-10	M100x2.0	0.787	3.189	3.622	2.756	4.921	5.551	120/89
053611-MNA	11-110	M110x2.0	0.787	3.583	3.976	2.756	5.315	5.984	175/129
053612-MNA	12-120	M120x2.0	0.787	3.976	4.291	2.756	5.512	6.220	175/129
053613-MNA	13-10	M130x2.0	0.787	4.291	4.567	2.756	5.748	6.457	175/129

Dimensions are in inches.

## FITTING INSTRUCTION

### ENCLOSURES AND EQUIPMENT TO WHICH CABLE GLANDS ARE FITTED:-

- Must be made from materials which are compatible with the cable gland materials.
- Have a sealing area around the cable gland entry point with a surface roughness < Ra 6.3 µm.
- Have entries that are perpendicular to the enclosure face in the area where the cable gland will seal to within 2.5°.
- Are sealed using the supplied sealing gasket (parallel threads) or by fully tightening into a threaded entry (tapered threads). Note that for tapered threads the IP rating can be improved to IP68 with the use of a suitable thread sealant.

### MUST HAVE THREADED ENTRIES

- The same thread size as the cable gland. (Thread adapters should be used to correct

any mismatch).

- With a thread tolerance of metric class '6H' or equivalent.
  - Where the thread length is a minimum of 10mm for Ex d applications or 3mm for all other applications
- OR CLEARANCE HOLES (not Ex d)**
- Where the hole size is the thread nominal size with a tolerance of +0.1 to +0.7mm. (e.g. the clearance hole for an M20 thread will have a diameter between 20.1mm and 20.7mm).
  - Through material that is between 1mm and 12mm thick. (Thicker materials can be accommodated using glands with extended entry threads.)

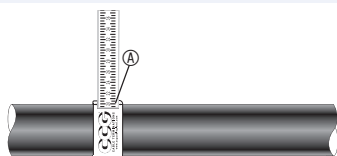

1. For accurate sizing, use a CCG Dimension Tape <sup>Ⓐ</sup> on the outer cable sheath.

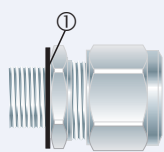

2. To maintain IP66/68, ensure the gasket <sup>Ⓛ</sup> is in place.

If the gland has NPT entry threads fitted to a threaded entry then IP68 (2m) can be achieved by applying one of the following tested and approved grease types to the thread:- Renolit Lubrene CA700 or LX220 EP2, Renolit LC-WP2 or Moly LX2, or Dow Corning 4 Electrical Compound.

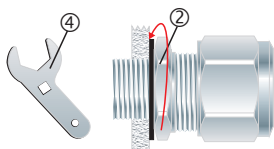

3. Screw the gland unit into the apparatus. Tighten the inner <sup>Ⓜ</sup> to the installation torque using a CCG Spanner <sup>Ⓓ</sup>.

Alternative installation through an unthreaded entry.

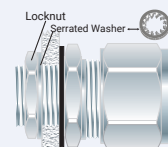

If the apparatus is unthreaded use a locknut.

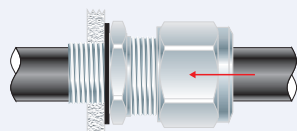

4. Pass the cable end through the gland assembly.

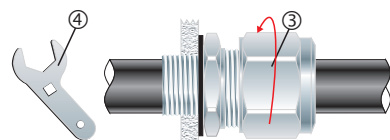

5. Tighten the outer nut <sup>Ⓝ</sup> to the installation torque using a CCG Spanner <sup>Ⓓ</sup> to produce a seal and grip on the cable.