



# A2F-FHC

Ex db IIC, Ex eb IIC, Ex ta IIIC, Ex nR IIC

COMPRESSION GLAND for Unarmoured Cable Housed In Conduit



## Features and Benefits

- For indoors, outdoors, Group II, III, Zone 1, 2, 20, 21 and 22 hazardous areas.
- For use with all types of unarmoured cable housed in rigid or flexible conduit.
- Fitted with a rotating female conduit coupler.
- Factory fitted with a specially formulated elastomeric seal for Built-in Safety™, acting on the sheath of the cable.
- Precision manufactured from high-quality brass (Marine Grade Electroless Nickel Plated™) available in aluminium or stainless steel 316/316L on request.
- Supplied with a thread sealing gasket (parallel threads only).

## Technical Data

|                          |  |
|--------------------------|--|
| Type:                    | A2F-FHC  |
| Gland Material:          | Brass (Marine Grade Electroless Nickel Plated™), Aluminium, Stainless Steel 316/316L         |
| Seal Material:           | Standard Thermoset Elastomer or Extreme Temperature Seals                                    |
| Sealing Gasket Material: | HDPE, Nylon 66 or PTFE   |
| Cable Type:              | Unarmoured Housed in Conduit   |
| Sealing Area:            | Cable Sheath   |
| Optional Accessories:    | Adaptor, Reducer, Earth Tag, Locknut, Serrated Washer  |
| Note:                    | The installer should ensure that the materials are suitable for the installation environment |

## Standards and Certifications

|                                    |   |
|------------------------------------|---|
| Equipment Protection Levels:       | IECEX: Ex db IIC Gb, Ex eb IIC Gb, Ex ta IIIC Da, Ex nR IIC Gc<br>ATEX/UKEX: Ex II 2/3G 1D, Ex db IIC Gb, Ex eb IIC Gb, Ex ta IIIC Da, Ex nR IIC Gc |
| Continuous Operating Temp:         | Standard Seals: -60°C to +95°C / 100°C (HDPE/ Nylon Sealing Gasket)<br>Extreme Temp. Seals: -60°C to +160°C (PTFE Sealing Gasket)                   |
| Conformance:                       | Standard: Certificate:  |
| IEC/BS EN                          | IEC/BS EN 62444 CML 14CA364   |
| IECEX                              | EN 60079 Part 0, 1, 7, 31 IECEx CML 20.0011   |
| ATEX                               | EN 60079 Part 0, 1, 7, 31 CML 20ATEX1026<br>EN 60079 Part 0, 15 CML 22ATEX4116  |
| UKEX                               | BS EN 60079 Part 0, 1, 7, 31 CML 22UKEX4117<br>BS EN 60079 Part 0, 15 CML 21UKEX4006X   |
| TR CU (Russia)                     | ГОСТ 31610-0, 15, ГОСТ IEC 60079-1 EA9C RU C-ZA.HA91.B.00245/21<br>ГОСТ P MЭК 60079-7, 31   |
| SANS                               | SANS/IEC 60079 Part 0, 1, 7, 15, 31 MASC MS/22-9001X  |
| IP66/68 100m - Parallel            | IEC 60529 IECEx CML 20.0011   |
| IP65/66 - Tapered                  | IEC 60529   |
| IP68 - Tapered and approved grease | IEC 60529   |
| Deluge Protection                  | DTS-01 CML 14CA370-2  |
| Corrosion Protection               | ASTM B117-11, BS EN ISO 3231 EXOVA N968667  |

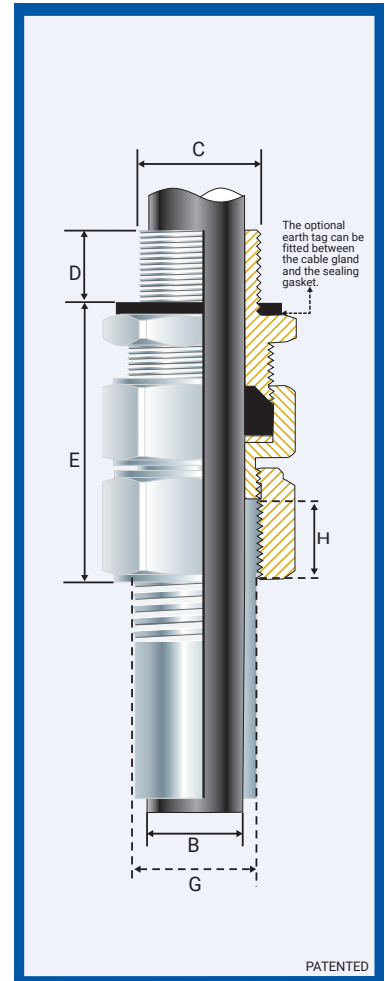

## Conditions for Safe Use - X

- None.
- Note: According to IEC 60079-14, 10.6.2: An Ex d gland will only maintain Ex d integrity when used with substantially round, compact and filled cable. If not a CCG VORTEX® or QuickStop-Ex® barrier gland should be used.

| Product Code | Gland Size Reference | Metric Entry Thread |         | NPT Entry Thread |         | Cable Detail |         | Max Length 'E' | Female Conduit Thread |                 |             |              | Hexagonal Detail |            | Install. Torque Value Nm |
|--------------|----------------------|---------------------|---------|------------------|---------|--------------|---------|----------------|-----------------------|-----------------|-------------|--------------|------------------|------------|--------------------------|
|              |                      | 'C'                 | Min 'D' | 'C'              | Min 'D' | Min 'B'      | Max 'B' |                | Metric 'G' (6g)       | Metric 'H' (mm) | NPT 'G'     | NPT 'H' (mm) | Max 'Flats'      | Max 'Crns' |                          |
| 044100-16S   | 00-16S               | M16x1.5             | 12      | -                | -       | 1.0          | 4.0     | 52.0           | M16-M25x1.5           | 12              | 1/2/3/4     | 15           | 24.0             | 27.0       | 32.5                     |
| 044100       | 00-20ss              | M20x1.5             | 12      | 1/2/3/4          | 15      | 3.0          | 8.5     | 52.0           | M16-M25x1.5           | 12              | 1/2/3/4     | 15           | 24.0             | 27.0       | 32.5                     |
| 0441-0       | 0-20s                | M20x1.5             | 12      | 1/2/3/4          | 15      | 7.0          | 12.0    | 50.0           | M16-M25x1.5           | 12              | 1/2/3/4     | 15           | 24.0             | 27.0       | 32.5                     |
| 044101       | 1-20                 | M20x1.5             | 12      | 1/2/3/4          | 15      | 11.0         | 15.0    | 52.0           | M16-M25x1.5           | 12              | 1/2/3/4     | 15           | 27.0             | 30.0       | 32.5                     |
| 044122       | 2s-25s               | M25x1.5             | 12      | 3/4/1            | 15/19   | 11.5         | 17.5    | 51.0           | M25x1.5               | 12              | 3/4/1       | 15/19        | 35.0             | 39.0       | 47.5                     |
| 044102       | 2-25                 | M25x1.5             | 12      | 3/4/1            | 15/19   | 15.0         | 20.0    | 51.0           | M25x1.5               | 12              | 3/4/1       | 15/19        | 35.0             | 39.0       | 47.5                     |
| 044133       | 3s-32s               | M32x1.5             | 12      | 1/1 1/4          | 19      | 16.0         | 22.0    | 57.0           | M32x1.5               | 12              | 1/1 1/4     | 19           | 42.0             | 47.0       | 55.0                     |
| 044103       | 3-32                 | M32x1.5             | 12      | 1/1 1/4          | 19      | 20.0         | 26.5    | 57.0           | M32x1.5               | 12              | 1/1 1/4     | 19           | 42.0             | 47.0       | 55.0                     |
| 044144       | 4s-40s               | M40x1.5             | 12      | 1 1/4/1 1/2      | 19/21   | 22.0         | 31.5    | 65.0           | M40x1.5               | 12              | 1 1/4/1 1/2 | 19/21        | 52.0             | 59.0       | 65.0                     |
| 044104       | 4-40                 | M40x1.5             | 12      | 1 1/4/1 1/2      | 19/21   | 26.0         | 34.0    | 65.0           | M40x1.5               | 12              | 1 1/4/1 1/2 | 19/21        | 52.0             | 59.0       | 65.0                     |
| 044155       | 5s-50s               | M50x1.5             | 12      | 1 1/2/2          | 21      | 29.0         | 38.0    | 73.0           | M50x1.5               | 12              | 1 1/2/2     | 21           | 65.0             | 73.0       | 82.5                     |
| 044105       | 5-50                 | M50x1.5             | 12      | 1 1/2/2          | 21      | 34.0         | 44.5    | 73.0           | M50x1.5               | 12              | 1 1/2/2     | 21           | 65.0             | 73.0       | 82.5                     |
| 044166       | 6s-63s               | M63x1.5             | 12      | 2/2 1/2          | 21/30   | 38.0         | 50.0    | 85.0           | M63x1.5               | 12              | 2/2 1/2     | 21/30        | 80.0             | 90.0       | 97.5                     |
| 044106       | 6-63                 | M63x1.5             | 12      | 2/2 1/2          | 21/30   | 44.5         | 56.5    | 85.0           | M63x1.5               | 12              | 2/2 1/2     | 21/30        | 80.0             | 90.0       | 97.5                     |
| 044177       | 7s-75s               | M75x1.5             | 12      | 2 1/2/3          | 30/32   | 50.0         | 62.0    | 86.0           | M75x1.5               | 12              | 2 1/2/3     | 30/32        | 96.0             | 108.0      | 115.5                    |
| 044107       | 7-75                 | M75x1.5             | 12      | 2 1/2/3          | 30/32   | 56.0         | 67.5    | 86.0           | M75x1.5               | 12              | 2 1/2/3     | 30/32        | 96.0             | 108.0      | 115.5                    |
| 044108       | 8-80                 | M80x2.0             | 16      | 3                | 32      | 59.0         | 69.0    | 98.0           | M80x2.0               | 16              | 3           | 32           | 96.0             | 108.0      | 120.0                    |
| 044199       | 9s-90s               | M90x2.0             | 16      | 3/3 1/2          | 33      | 60.0         | 75.0    | 105.0          | M90x2.0               | 16              | 3/3 1/2     | 33           | 111.0            | 125.0      | 120.0                    |
| 044109       | 9-90                 | M90x2.0             | 16      | 3/3 1/2          | 33      | 73.0         | 81.5    | 105.0          | M90x2.0               | 16              | 3/3 1/2     | 33           | 111.0            | 125.0      | 120.0                    |
| 044110       | 10-100               | M100x2.0            | 16      | 3/3 1/2/4        | 34      | 81.0         | 92.0    | 106.0          | M100x2.0              | 16              | 3/4         | 34           | 125.0            | 141.0      | 120.0                    |

All dimensions except NPT are in mm. Male Entry Thread 'C' and Female Entry Thread 'B' can only be any combination of either NPT or Metric threads. Intermediate thread sizes are available on request. NPT threads should be tightened 'wrench tight'.

CCG reserves the right to make alterations to the technical data, dimensions, designs and products available without notice. The illustrations cannot be considered binding. Please contact CCG for assistance.

A2F\_FHC-GH200622E

# A2F-FHC COMPRESSION GLAND

### ENCLOSURES AND EQUIPMENT TO WHICH CABLE GLANDS ARE FITTED:-

- Must be made from materials which are compatible with the cable gland materials.
- Have a sealing area around the cable gland entry point with a surface roughness <math>< Ra 6.3 \mu m.</math>
- Have entries that are perpendicular to the enclosure face in the area where the cable gland will seal to within 2.5°.
- Are sealed using the supplied sealing gasket (parallel threads) or by fully tightening into a threaded entry (tapered threads). Note that for tapered threads the IP rating can be improved to IP68 with the use of a suitable thread sealant.

### MUST HAVE THREADED ENTRIES

- The same thread size as the cable gland. (Thread adapters should be used to correct

any mismatch).

- With a thread tolerance of metric class '6H' or equivalent.
- Where the thread length is a minimum of 10mm for Ex d applications or 3mm for all other applications

### OR CLEARANCE HOLES (not Ex d)

- Where the hole size is the thread nominal size with a tolerance of +0.1 to +0.7mm. (e.g. the clearance hole for an M20 thread will have a diameter between 20.1mm and 20.7mm).
- Through material that is between 1mm and 12mm thick. (Thicker materials can be accommodated using glands with extended entry threads.)

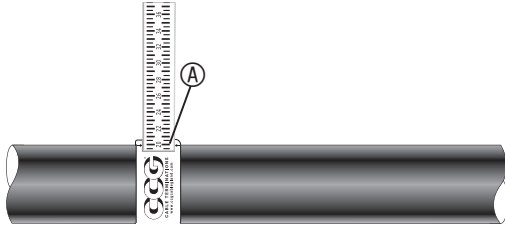

1. For accurate sizing, use a CCG Dimension Tape (A) on the outer cable sheath.

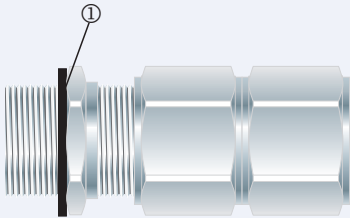

2. To maintain IP66/68, ensure the gasket (1) is in place.

If the gland has NPT entry threads fitted to a threaded entry then IP68 (2m) can be achieved by applying one of the following tested and approved grease types to the thread: Renolit Lubrene CA700 or LX220 EP2, Renolit LC-WP2 or Moly LX2, or Dow Corning 4 Electrical Compound.

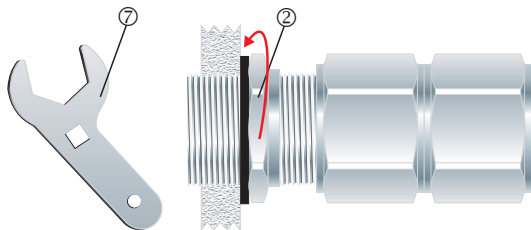

3. Screw the gland unit into the apparatus. Tighten the inner until hand tight (2) using a CCG Spanner (7) with ¼ turn.

Alternative installation through an unthreaded entry.

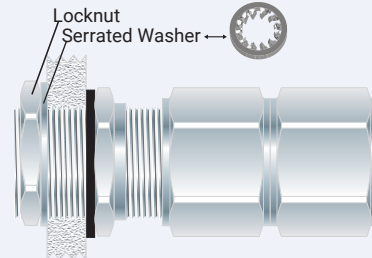

If the apparatus is untapped use a locknut.

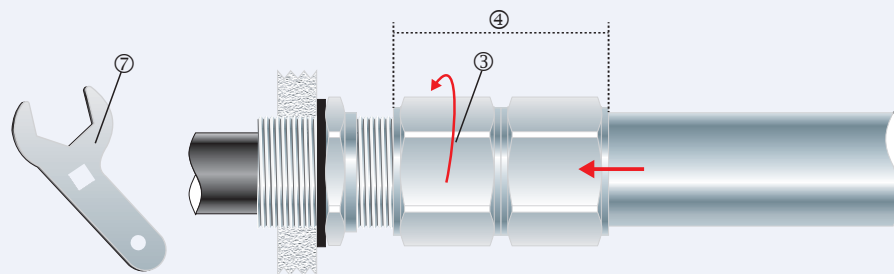

4. Pass the cable end through the conduit assembly (4) and the gland assembly. Tighten the outer (3) to the installation torque using a CCG Spanner (7) to produce a seal and grip on the cable.

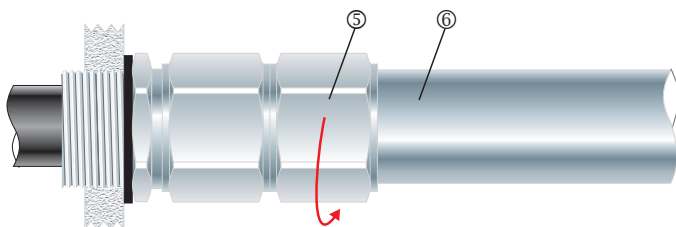

5. Fit the threaded conduit end (6) into the female rotating threads (5) as indicated.