

A2F-H-R

Ex db I/IIC, Ex eb I/IIC, Ex ta IIIC, Ex nR IIC

COMPRESSION GLAND for Single or Multi-Core Unarmoured Cable



Features and Benefits

- For Group I, II, III, Zone 1, 2, 20, 21 and 22 hazardous areas.
- Fitted with a specially formulated elastomeric displacement seal for superior cable retention, explosion protection and IP rating.
- A hose tail provides for clamping a protective hose over the cable.
- Precision manufactured from high-quality brass (Marine Grade Electroless Nickel Plated™) is available in stainless steel 316/316L on request
- Supplied with a thread-sealing gasket (parallel threads only).

Technical Data

Type:	A2F-H-R
Gland Material:	Brass (Marine Grade Electroless Nickel Plated™), Stainless Steel 316/316L
Seal Material:	Standard Thermoset Elastomer or Extreme Temperature Seals
Sealing Gasket Material:	HDPE, Nylon 66 or PTFE
Cable Type:	Single or Multi-Core Unarmoured
Sealing Area:	Outer Sheath
Optional Accessories:	Adaptor, Reducer, Earth Tag, Locknut, Serrated Washer and Shroud
Note:	The installer should ensure that the materials are suitable for the installation environment.

Standards and Certifications

Equipment Protection Levels:	IECEX/INMETRO: Ex db eb I Mb, Ex db eb IIC Gb, Ex nR IIC Gc, Ex ta IIIC Da ATEX/UKEX: Ⓢ I M2, Ⓢ II 2/3G 1D, Ex db eb I Mb, Ex db eb IIC Gb, Ex nR IIC Gc, Ex ta IIIC Da TR CU: Ⓢ 1Ex d I Mb X, 2Ex e I Mc X, 1Ex d IIC Gb X, 1Ex e IIC Gb X, 2Ex nR IIC Gc X, Ex tb IIIC Db X CCC: Ex db IIC Gb, Ex eb IIC Gb, Ex ta IIIC Da
------------------------------	---------------------------------------------------------------------------------------------------------------------------------------------------------------------------------------------------------------------------------------------------------------------------------------------------------------------------------------

Continuous Operating Temp: Standard Seals: -60°C to +95°C /100°C (HDPE/ Nylon Sealing Gasket)
Extreme Temp. Seals: -60°C to +160°C (PTFE Sealing Gasket)

Conformance:	Standard:	Certificate:
IEC/BS EN	IEC/BS EN 62444	CML 14CA364
IECEX	IEC 60079 Part 0, 1, 7, 15, 31	IECEX TSA 23.0026
ATEX	EN 60079 Part 0, 1, 7, 31	CML 20ATEX1026
	EN 60079 Part 0, 15	CML 22ATEX4116
UKEX	BS EN 60079 Part 0, 1, 7, 31	CML 21UKEX1013
	BS EN 60079 Part 0, 15	CML 22UKEX4117
INMETRO (Brazil)	ABNT NBR IEC 60079 Part 0, 1, 7, 15, 31	TÜV 24.0267
TR CU (Russia)	ГОСТ 31610-0, 15, ГОСТ IEC 60079-1	EA9C RU C-ZA.HA91.B.00245/21
	ГОСТ P M9K 60079-7, 31	
CCC/CNEx (Chinese)	GB/T3836.1, 2, 3, 31-2021	CNEx 21.3389X, CCC 2021312313000392
SANS	SANS/IEC 60079 Part 0, 1, 7, 15, 31	MASC MS/22-9001X
IP66/68 850m - Parallel	IEC 60529	CML 15Y728
IP65/66 - Tapered	IEC 60529	
IP68 - Tapered and approved grease	IEC 60529	IECEX TSA 23.0026
Deluge Protection	DTS-01	CML 14CA370-2
Corrosion Protection	ASTM B117-11, BS EN ISO 3231	EXOVA N968667

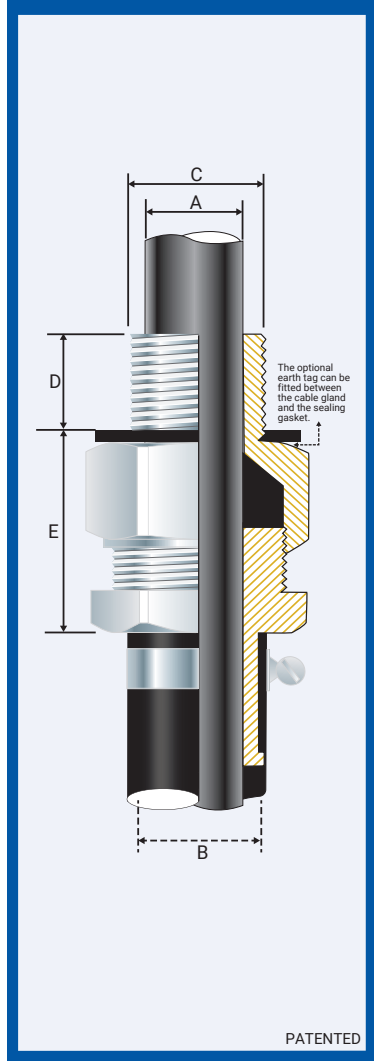

Conditions for Safe Use - X

- None.

Note: According to IEC 60079-14, 10.6.2: An Ex d gland will only maintain Ex d integrity when used with substantially round, compact and filled cable. If not a If not a CCG VORTEX® barrier gland should be used.

Product Code	Gland Size Reference	Metric Entry Thread		NPT Entry Thread		Cable Detail		Maximum Length 'E'	Spigot/Hose Tail 'B'	Hexagonal Detail		Install. Torque Value Nm
		'C'	Min 'D'	'C'	Min 'D'	Min 'A'	Max 'A'			Max 'Flats'	Max 'Crns'	
049700-16S	00s-16S	M16x1.5	15	-	-	1.0	4.0	43.0	16.0/19.0	24.0	27.0	32.5
049700-16	00-16ss	M16x1.5	15	-	-	3.0	8.5	43.0	16.0/19.0	24.0	27.0	32.5
049700	00-20ss	M20x1.5	15	1/2/3/4	15	3.0	8.5	43.0	16.0/19.0	24.0	27.0	32.5
0497-0-16	00-16s	M16x1.5	15	1/2/3/4	15	7.0	10.5	43.0	16.0/19.0	24.0	27.0	32.5
0497-0	0-20s	M20x1.5	15	1/2/3/4	15	7.0	12.0	43.0	16.0/19.0	24.0	27.0	32.5
049701	1-20	M20x1.5	15	1/2/3/4	15	11.0	15.0	50.0	17.5/19.0	27.0	30.0	32.5
049722	2s-25s	M25x1.5	15	3/4/1	15/19	11.5	17.5	55.5	25.4	35.0	39.0	47.5
049702	2-25	M25x1.5	15	3/4/1	15/19	15.0	20.0	55.5	25.4	35.0	39.0	47.5
049733	3s-32s	M32x1.5	15	1/1 1/4	19	16.0	22.0	66.0	31.8	42.0	47.0	55.0
049703	3-32	M32x1.5	15	1/1 1/4	19	20.0	26.5	66.0	31.8	42.0	47.0	55.0
049744	4s-40s	M40x1.5	15	1 1/4/1 1/2	19/21	22.0	31.5	80.0	38.1	52.0	59.0	65.0
049704	4-40	M40x1.5	15	1 1/4/1 1/2	19/21	26.0	34.0	80.0	38.1	52.0	59.0	65.0
049755	5s-50s	M50x1.5	15	1 1/2/2	21	29.0	38.0	90.0	50.8	65.0	73.0	82.5
049705	5-50	M50x1.5	15	1 1/2/2	21	34.0	44.5	99.0	50.8	65.0	73.0	82.5
049766	6s-63s	M63x1.5	15	2/2 1/2	21/30	38.0	50.0	121.0	63.5	80.0	90.0	97.5
049706	6-63	M63x1.5	15	2/2 1/2	21/30	44.5	56.5	121.0	63.5	80.0	90.0	97.5
049777	7s-75s	M75x1.5	15	2 1/2/3	30/32	50.0	62.0	141.0	76.0	96.0	108.0	115.5
049707	7-75	M75x1.5	15	2 1/2/3	30/32	56.0	67.5	141.0	76.0	96.0	108.0	115.5

All dimensions except NPT are in mm. Intermediate thread sizes are available on request. NPT threads should be tightened 'wrench tight'.

CCG reserves the right to make alterations to the technical data, dimensions, designs and products available without notice. The illustrations cannot be considered binding. Please contact CCG for assistance.

A2FH-R_HMG051224E

A2F-H-R COMPRESSION GLAND

ENCLOSURES AND EQUIPMENT TO WHICH CABLE GLANDS ARE FITTED:-

- Must be made from materials which are compatible with the cable gland materials.
- Have a sealing area around the cable gland entry point with a surface roughness <math>< Ra 6.3 \mu m</math>.
- Have entries that are perpendicular to the enclosure face in the area where the cable gland will seal to within 2.5°.
- Are sealed using the supplied sealing gasket (parallel threads) or by fully tightening into a threaded entry (tapered threads). Note that for tapered threads the IP rating can be improved to IP68 with the use of a suitable thread sealant.

MUST HAVE THREADED ENTRIES

- The same thread size as the cable gland. (Thread adapters should be used to correct

any mismatch).

- With a thread tolerance of metric class '6H' or equivalent.
- Where the thread length is a minimum of 10mm for Ex d applications or 3mm for all other applications

OR CLEARANCE HOLES (not Ex d)

- Where the hole size is the thread nominal size with a tolerance of +0.1 to +0.7mm. (e.g. the clearance hole for an M20 thread will have a diameter between 20.1mm and 20.7mm).
- Through material that is between 1mm and 12mm thick. (Thicker materials can be accommodated using glands with extended entry threads.)

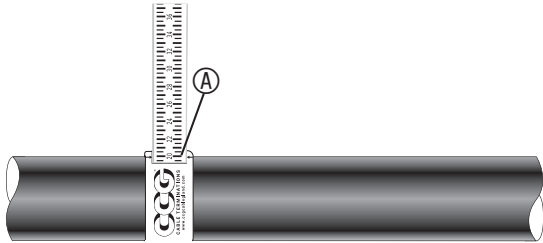

1. For accurate sizing, use a CCG Dimension Tape ④ on the outer cable sheath.

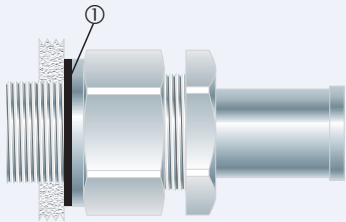

2. To maintain IP66/68 ensure the gasket ① is in place.

If the gland has NPT entry threads fitted to a threaded entry then IP68 (2m) can be achieved by applying one of the following tested and approved grease types to the thread:- Renolit Lubrene CA700 or LX220 EP2, Renolit LC-WP2 or Moly LX2, or Dow Corning 4 Electrical Compound.

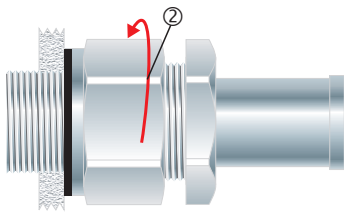

3. Screw the inner ② into the apparatus. Tighten the inner ② to the installation torque using a CCG Spanner ④.

Alternative installation through an unthreaded entry.

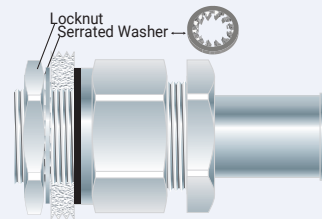

If the apparatus is untapped use a locknut.

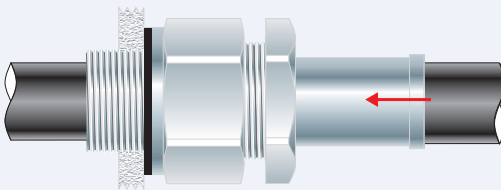

4. Pass the cable end through the gland assembly.

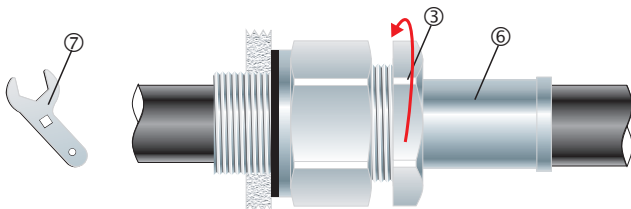

5. Tighten the outer nut ③ to the installation torque using a CCG Spanner ⑦ to produce a seal and grip on the cable.

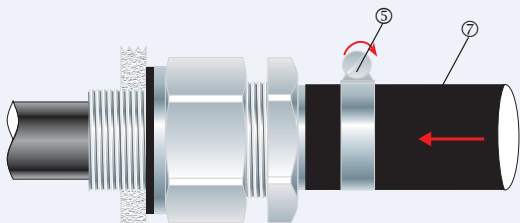

6. Slide the protective hose ⑦ over the hose tail ⑥ and tighten the hose clamp ⑤.