



# A2F-FHC VX

Ex db IIC, Ex eb IIC, Ex ta IIIC, Ex nR IIC

**VORTEX** BARRIER COMPRESSION GLAND for Single or Multi-Core Unfilled Unarmoured Cable Housed In Conduit

## Features and Benefits

- For indoors, outdoors, Group II, III, Zone 1, 2, 20, 21 and 22 hazardous areas.
- For use with all types of unarmoured cable housed in rigid or flexible conduit.
- Fitted with a rotating female conduit coupler.
- Outer seal grips the cable, giving superior cable retention and IP rating.
- Instantly mixed and injected Resin forms a 100% barrier seal around the individual cores of the cable.
- Prevents explosive gases and/or liquids transmitting down the cable.
- Precision manufactured from high-quality brass (Marine Grade Electroless Nickel Plated™) available in aluminium or stainless steel 316/316L on request.
- Complete with thread-sealing gasket.



## Technical Data

Type:	A2F-FHC VX (Vortex®)
Gland Material:	Brass (Marine Grade Electroless Nickel Plated™) Aluminium, Stainless Steel 316/316L
Seal Material:	Standard Thermoset Elastomer or Extreme Temperature Seals, Quick setting Injection Resin Barrier Seal
Sealing Gasket Material:	HDPE, Nylon 66 or PTFE
Cable Type:	Single or Multi-Core Unarmoured Housed in Conduit
Sealing Area:	Outer Sheath and VORTEX® Resin around Cable Conductors
Optional Accessories:	Adaptor, Reducer, Earth Tag, Locknut, Serrated Washer
Note:	The installer should ensure that the materials are suitable for the installation environment

## Standards and Certifications

Equipment Protection Levels:	IECEx/INMETRO: Ex db IIC Gb, Ex eb IIC Gb, Ex nR IIC Gc, Ex ta IIIC Da ATEX/UKEX: Ex II 2/3G 1D, Ex db IIC Gb, Ex eb IIC Gb, Ex ta IIIC Da, Ex nR IIC Gc	
Continuous Operating Temp:	-60°C to +100°C	
Conformance:	Standard: Certificate:	
IEC/BS EN	IEC/BS EN 62444	CML 14CA364
IECEX	EN 60079 Part 0, 1, 7, 31	IECEX CML 20.0011
ATEX	EN 60079 Part 0, 1, 7, 31 EN 60079 Part 0, 15	CML 20ATEX1026 CML 22ATEX4116
UKEX	BS EN 60079 Part 0, 1, 7, 31 BS EN 60079 Part 0, 15	CML 21UKEX1013 CML 22UKEX4117
INMETRO (Brazil)	ABNT NBR IEC 60079 Part 0, 1, 7, 15, 31	TÜV 24.0267
TR CU (Russia)	ГОСТ 31610-0, 15, ГОСТ IEC 60079-1 ГОСТ Р МЭК 60079-7, 31	EAЭC RU C-ZA.HA91.B.00245/21
SANS	SANS/IEC 60079 Part 0, 1, 7, 15, 31	MASC MS/22-9001X
IP66/68 100m - Parallel	IEC 60529	CML 15Y728
IP65 - Tapered	IEC 60529	
IP68 - Tapered and approved grease	IEC 60529	IECEX CML 20.0011
Deluge Protection	DTS-01	CML 14CA370-2
Corrosion Protection	ASTM B117-11, BS EN ISO 3231	EXOVA N968667
Marine DNV	IEC 60079 Part 0, 1, 7, IEC 60529	TAE0000010
EMC Compatible	EN 55011, + A1, EN 55022	SGS EMC305079/1

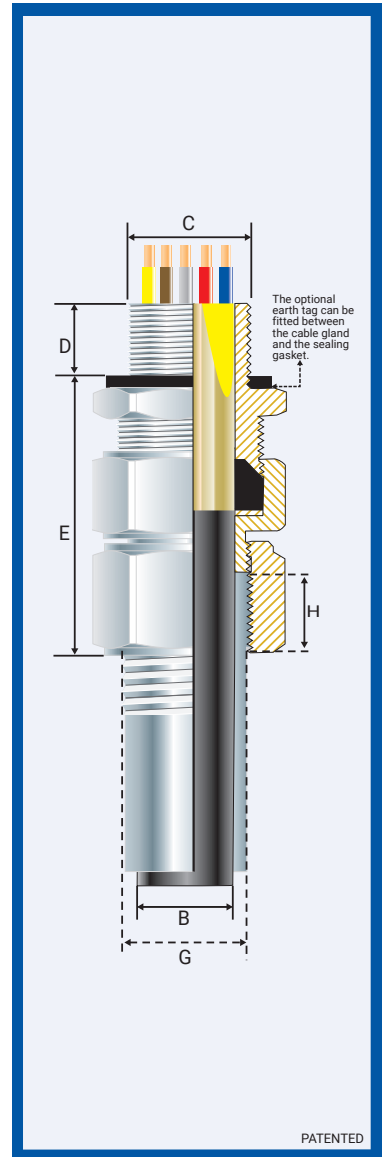

## Conditions for Safe Use - X

None

Product Code	Gland Size Ref	Metric Entry Thread		NPT Entry Thread		Cable Detail		Max Length 'E'	Female Conduit Thread				Max Dia. Over Cores	Max No. of Cores	Hexagonal Detail		Install. Torque Value Nm
		'C'	Min 'D'	'C'	Min 'D'	Min 'B'	Max 'B'		Metric 'G' (6g)	Metric 'H' (mm)	NPT 'G'	NPT 'H' (mm)			Max 'Flats'	Max 'Crns'	
0468-0-VX	0-20s	M20x1.5	12 1/2	15	3.0	12.0	49.5	M16-M25 x 1.5	12	1/2 3/4	15	10.9	10	24.0	27.0	32.5	
046801-VX	1-20	M20x1.5	12 1/2	15	9.0	15.0	47.5	M16-M25 x 1.5	12	1/2 3/4	15	12.5	25	27.0	30.0	32.5	
046802-VX	2-25	M25x1.5	12 3/4	15	11.0	20.0	46.0	M25 x 1.5	12	3/4 1	15/19	16.5	48	35.0	39.0	47.5	
046803-VX	3-32	M32x1.5	12 1 1/4	19	16.0	26.5	52.0	M32 x 1.5	12	1 1/4	19	24.0	76	42.0	47.0	55.0	
046804-VX	4-40	M40x1.5	12 1 1/4 1/2	19/21	22.0	34.0	64.0	M40 x 1.5	12	1 1/4 1 1/2	19/21	32.0	96	52.0	59.0	65.0	
046805-VX	5-50	M50x1.5	12 2	21	29.0	44.5	65.0	M50 x 1.5	12	1 1/2 2	21	36.3	96	65.0	73.0	82.5	
046806-VX	6-63	M63x1.5	12 2 1/2	30	38.0	56.5	78.0	M63 x 1.5	12	2 1/2 3	21/30	47.9	100	80.0	90.0	97.5	
046807-VX	7-75	M75x1.5	12 3	32	56.0	67.5	79.0	M75 x 1.5	12	2 1/2 3	30/32	60.0	120	96.0	108.0	115.5	
046808-VX	8-80	M80x2.0	16 3	32	59.0	69.0	79.0	M80 x 2.0	16	3	32	61.5	140	96.0	108.0	120.0	
046809-VX	9-90	M90x2.0	16 3 1/2	33	66.0	81.5	87.0	M90 x 2.0	16	3 3/2	33	70.5	160	111.0	125.0	120.0	
046810-VX	10-100	M100x2.0	16 4	34	72.0	92.0	88.0	M100 x 2.0	16	4	34	79.0	180	125.0	141.0	120.0	

All dimensions except NPT are in mm. Male Entry Thread 'C' and Female Entry Thread 'B' can be any combination of either NPT or Metric threads.

Intermediate thread sizes are available on request.

CCGG reserves the right to make alterations to the technical data, dimensions, designs and products available without notice. The illustrations cannot be considered binding. Please contact CCGG for assistance.

A2F\_FHC VX-BG051224E

# A2F-FHC VX (VORTEX®) BARRIER COMPRESSION GLAND

### ENCLOSURES AND EQUIPMENT TO WHICH CABLE GLANDS ARE FITTED:-

- Must be made from materials which are compatible with the cable gland materials.
- Have a sealing area around the cable gland entry point with a surface roughness <math>< Ra 6.3 \mu m</math>.
- Have entries that are perpendicular to the enclosure face in the area where the cable gland will seal to within 2.5°.
- Are sealed using the supplied sealing gasket (parallel threads) or by fully tightening into a threaded entry (tapered threads). Note that for tapered threads the IP rating can be improved to IP68 with the use of a suitable thread sealant.

### MUST HAVE THREADED ENTRIES

- The same thread size as the cable gland. (Thread adapters should be used to correct

any mismatch).

- With a thread tolerance of metric class '6H' or equivalent.
- Where the thread length is a minimum of 10mm for Ex d applications or 3mm for all other applications

### OR CLEARANCE HOLES (not Ex d)

- Where the hole size is the thread nominal size with a tolerance of +0.1 to +0.7mm. (e.g. the clearance hole for an M20 thread will have a diameter between 20.1mm and 20.7mm).
- Through material that is between 1mm and 12mm thick. (Thicker materials can be accommodated using glands with extended entry threads.)

1. Strip back the outer sheath to expose the inner cable cores. Using a clean cloth, clean the cable cores insulation.

If the cable cores have screens these should be cut away or twisted together into a single core. This single core should be insulated with heat shrink tubing or coated with insulating varnish. Any drain wires should also be insulated with heat shrink tubing or coated with insulating varnish.



2. Using insulation tape, bundle the cores together at the end.

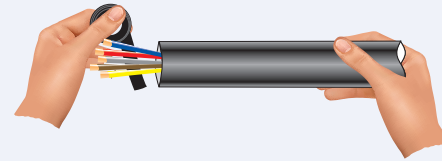

3. To maintain IP66/68, ensure the thread gasket ① is in place. Screw the gland unit into the apparatus. Tighten the inner ② until hand tight using a CCG Spanner ⑧ with ¼ turn. If the apparatus is untapped use a locknut.

If the gland has NPT entry threads fitted to a threaded entry then IP68 (2m) can be achieved by applying one of the following tested and approved grease types to the thread:- Renolit Lubrene CA700 or LX220 EP2, Renolit LC-WP2 or Moly LX2, or Dow Corning 4 Electrical Compound.

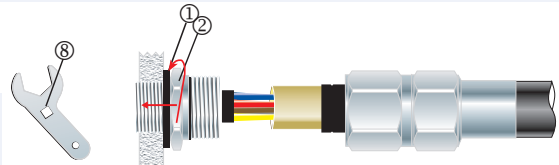

4. Pass the bundled cable cores through the outer ③ and female rotating thread ④. Pass the bundled cables cores through the inner ② and inner diaphragm seal.

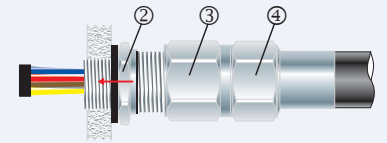

5. Tighten the outer ③ onto the inner ② until hand tight, then tighten with a CCG Spanner ⑧ with ¾ turn.

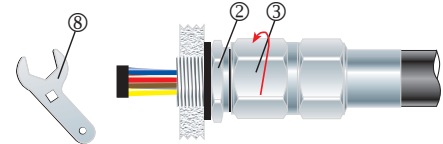

6. Unscrew the outer ③. Withdraw the barrier pot sub-assembly ⑤ and bundled cable. Remove the insulation tape.

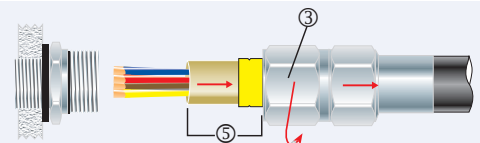

Only Resin supplied by CCG may be used in the glands.

7. Remove the cap ⑧ from resin applicator and attach the mixing nozzle ⑩ (use extension nozzle for small multicore cables). Whilst holding the barrier pot sub-assembly ⑤ upright and holding the diaphragm seal firmly against the cable sheath inject the resin into the resin chamber\*. Ensure the resin fills the inspectible resin seal pot ⑥ all the way to the top of the protective resin pot ⑦ and wipe any excess resin away.

Wait for the resin to change from a liquid to a solid state, this should take:

- 15 minutes at 10°C
- 7 minutes at 20°C
- 6 minutes at 30°C
- 5 minutes at 40°C

The cable gland can now be handled safely, and the resin will continue to cure until it reaches its full hardness. For installations in less than 5°C Ambient, warm the Resin Tube in warm water at ± 50°C.

If there is still resin left in the tube, discard the mixing nozzle ⑩ and replace the cap ⑧ for use with the next gland.

\* The installation is acceptable if the cable sheath is pushed 2mm or 3mm into the resin seal.

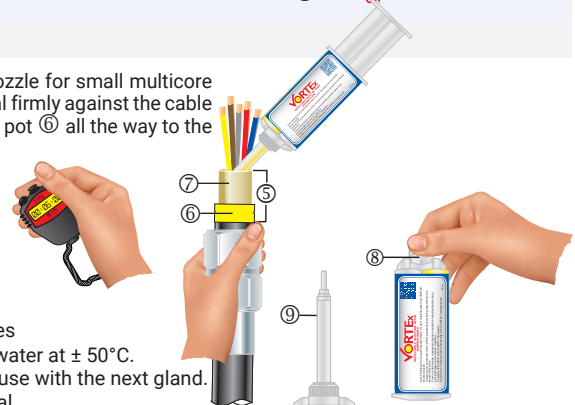

8. Pass the cable end through the barrier pot sub-assembly ⑤ and through the inner ②.

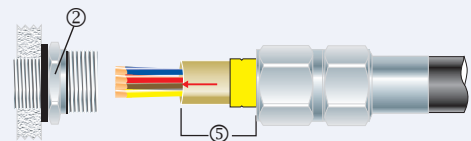

9. Tighten the outer ③ onto the inner ② to the installation torque using a CCG Spanner ⑧. Fit the threaded conduit thread ⑩ into the female rotating threads ④ as indicated.

