

UNITEx™-F

CABLE GLAND WITH VARIABLE DELUGE SEAL for Multi Armoured Tray and Marine Shipboard Cable



Features and Benefits

- Gland for use in Ordinary and Hazardous Locations.
- Two part handling, no loose parts. Freely rotating captive cone and inspectible cone ring provides an armour clamp and earth bond on steel wire armour, aluminium wire armour, tape armour, braid wire armour cables.
- With a patented Variable Deluge Seal™ as standard.
- Patented disconnect system that allows inspection of armour clamp and inner seal after assembly.
- Factory fitted with specially formulated elastomeric seals for Built-in Safety™. Seals on the outer sheath of the cable to IP65/66/68.
- Unique low-contact IP68 inner seal making this gland suitable for use with NEK 606 marine cables susceptible to coldflow.
- Precision manufactured from high-quality brass (Marine Grade Electroless Nickel Plated™) available in aluminium and stainless steel 316/316L on request. Complete with thread sealing gasket.



Technical Data

Type:	UNITEx™-F
Gland Material:	Brass (Marine Grade Electroless Nickel Plated™), Stainless Steel 316/316L
Seal Material:	Standard Thermoset Elastomer or Extreme Temperature Seals
Sealing Gasket Material:	HDPE, Nylon 66 or PTFE
Cable Type:	Steel or Aluminium Wire Armoured, Braided and Tape Armoured Tray and Marine Shipboard Cable
Armour Clamping:	Rotating Captive Cone and Inspectible Cone Ring
Sealing Area:	Inner Sheath, Outer Sheath and Variable Deluge Seal™
Optional Accessories:	Adaptor, Reducer, Earth Tag, Locknut, Serrated Washer and Shroud
Note:	The installer should ensure that the materials are suitable for the installation environment.

Temperature Range

When fitted with sealing gaskets the temperature range for the gland will be:-

Sealing Gasket Material:	Standard Seals: -60°C and +95°C (HDPE/Nylon Sealing Gasket)
	Extreme Temp. Seals: -60°C and +160°C (PTFE Sealing Gasket)

Standards and Certifications

Equipment Protection Levels:	NEC/CEC: CI I Div 2 Gr ABCD, CI II Div 2 Gr FG, CI III Div 2, CI I Zn 1 AEx eb IIC Gb / Ex eb IIC Gb Zn 21 AEx ta IIIC Da / Ex ta IIIC Da, CI I Zn 2 AEx nR IIC Gc / Ex nR IIC Gc, IP66/67/68, IP65, Type 4 IECEX: Ex eb IIC Gb, Ex nR IIC Gc, Ex ta IIIC Da	
Conformance:	Standard:	Certificate:
CEC	CSA C22.2 No. 18.3-12, 174:2018 & 213:2017 CSA C22.2 No. 60079 - 0, 1, 7, 15, 31	E115594
NEC	UL514B, UL121201 UL 60079 - 0, 7, 15, 31	
IECEX	IEC 60079 - 0, 1, 7, 15, 31	IECEX CML 18.0018X CML 15Y728 and IECEX CML 18.0018X
IP66/68 850m - Parallel	IEC 60529	
IP68 – Tapered and approved grease	IEC 60529	
Nema Type 4X	NEMA 250	E115594
Deluge Protection	DTS-01	CML 14CA370-2
Corrosion Protection	ASTM B117-11, BS EN ISO 3231	EXOVA N968667
Marine ABS	IEC 60079 Part 0, 1, 7, 15, 31, IEC 60529	ABS 20-1952706-1-PDA
DNV-GL	IEC 60079 Part 0, 1, 7, IEC 60529	DNV-GL TAE0000010
EMC Compatible	EN 55011, + A1, EN 55022	SGS EMC305079/1

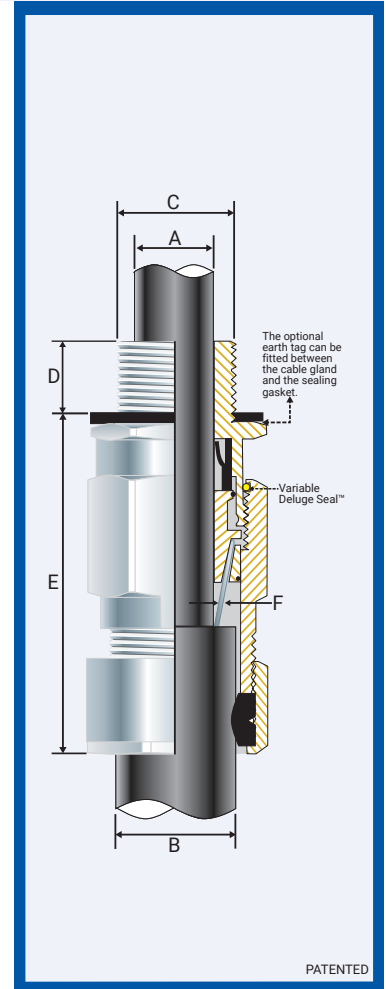

Conditions for Safe Use - X

- The cable glands M20, ¼" NPT and smaller shall only be used on fixed installations where the cable is clamped, or stress applied to the cable in the gland is prevented - IECEx only.
- The cable glands shall only be used where the temperature, at the point of entry, is between -60°C and +95°C (standard seal & HDPE sealing gasket), +100°C (standard seal and Nylon sealing gasket) or +160°C (extreme temp. seal & PTFE sealing gasket) depending on seal and gasket used.
- Braided cables must only be used on fixed installations where the cable is clamped or stress applied to the cable in the gland is prevented - IECEx only.

NPT Entry Thread

Gland Size Reference	Product Code	NPT Entry Thread		Alternative Thread Product Code	NPT Entry Thread		Cable Detail				Max Length 'E'	Armour Dia.		Hex. Detail	
		'C'	Min 'D'		'C'	Min 'D'	Min 'A'	Max 'A'	Min 'B'	Max 'B'		Min 'F'	Max 'F'	Max 'Flats'	Max 'Crns'
00s-20ss	051000S-012NPT-MNA	½	0.590	051000S-034NPT-MNA	¾	0.590	0.118	0.335	0.197	0.413	2.204	0.008	0.035	0.945	1.063
00-20ss	051000-012NPT-MNA	½	0.590	051000-034NPT-MNA	¾	0.590	0.118	0.335	0.315	0.551	2.204	0.008	0.035	0.945	1.063
0s-20s	0510-0S-012NPT-MNA	½	0.590	0510-0S-034NPT-MNA	¾	0.590	0.275	0.472	0.315	0.551	2.322	0.008	0.049	0.945	1.063
0-20s	0510-0-012NPT-MNA	½	0.590	0510-0-034NPT-MNA	¾	0.590	0.275	0.472	0.453	0.630	2.322	0.008	0.049	0.945	1.063
1-20	051001-012NPT-MNA	½	0.590	051001-034NPT-MNA	¾	0.590	0.354	0.590	0.492	0.807	2.873	0.008	0.049	1.063	1.181
2s-25s	051022-034NPT-MNA	¾	0.590	051022-001NPT-MNA	1	0.748	0.433	0.689	0.630	0.964	3.227	0.008	0.063	1.377	1.535
2-25	051002-034NPT-MNA	¾	0.590	051002-001NPT-MNA	1	0.748	0.551	0.787	0.708	1.063	3.227	0.008	0.063	1.377	1.535
3s-32s	051033-001NPT-MNA	1	0.748	051033-114NPT-MNA	1¼	0.748	0.590	0.866	0.787	1.200	3.699	0.008	0.079	1.653	1.850
3-32	051003-001NPT-MNA	1	0.748	051003-114NPT-MNA	1¼	0.748	0.748	1.043	0.905	1.318	3.699	0.008	0.079	1.653	1.850
4s-40s	051044-114NPT-MNA	1¼	0.748	051044-112NPT-MNA	1½	0.826	0.866	1.240	1.043	1.535	3.935	0.012	0.079	2.046	2.322
4-40	051004-114NPT-MNA	1¼	0.748	051004-112NPT-MNA	1½	0.826	1.023	1.338	1.102	1.574	4.132	0.012	0.079	2.046	2.322
5s-50s	051055-112NPT-MNA	1½	0.826	051055-002NPT-MNA	2	0.826	1.141	1.495	1.385	1.869	4.762	0.016	0.098	2.558	2.873
5-50	051005-112NPT-MNA	1½	0.826	051005-002NPT-MNA	2	0.826	1.338	1.751	1.747	2.078	4.762	0.016	0.098	2.558	2.873
6s-63s	051066-002NPT-MNA	2	0.826	051066-212NPT-MNA	2½	1.181	1.495	1.968	1.791	2.381	4.959	0.016	0.098	3.148	3.542
6-63	051006-002NPT-MNA	2	0.826	051006-212NPT-MNA	2½	1.181	1.732	2.224	2.149	2.593	4.959	0.016	0.098	3.148	3.542
7s-75s	051077-212NPT-MNA	2½	1.181	051077-003NPT-MNA	3	1.259	1.968	2.440	2.322	2.853	5.431	0.016	0.124	3.778	4.250
7-75	051007-212NPT-MNA	2½	1.181	051007-003NPT-MNA	3	1.259	2.204	2.656	2.558	3.070	5.431	0.016	0.124	3.778	4.250
8-80	051008-003NPT-MNA	3	1.259	-	-	-	2.322	2.715	2.558	3.050	5.588	0.016	0.124	3.778	4.250
9s-90s	051099-003NPT-MNA	3	1.259	051099-312NPT-MNA	3½	1.299	2.597	2.952	2.873	3.404	6.139	0.016	0.138	4.368	4.919
9-90	051009-003NPT-MNA	3	1.259	051009-312NPT-MNA	3½	1.299	2.912	3.207	3.227	3.581	6.139	0.016	0.138	4.368	4.919
10-10	051010-312NPT-MNA	3½	1.299	051010-004NPT-MNA	4	1.338	3.188	3.581	3.542	3.935	6.808	0.016	0.138	4.919	5.549

All dimensions are in inches. NPT threads should be tightened 'wrench tight'

CCG reserves the right to make alterations to the technical data, dimensions, designs and products available without notice. The illustrations cannot be considered binding. Please contact CCG for assistance. UNITEx-OMG250123NA

Metric Entry Thread

Gland Size Reference	Product Code	Metric Entry Thread		Cable Detail				Max Length 'E'	Armour Dia		Hexagonal Detail		Tightening Torque Nm/lb ft
		'C'	Min 'D'	Min 'A'	Max 'A'	Min 'B'	Max 'B'		Min 'F'	Max 'F'	Max 'Flats'	Max 'Crns'	
00s-20ss	051000S-MNA	M20x1.5	0.591	0.118	0.335	0.197	0.413	2.205	0.008	0.035	0.945	1.063	21/15
00-20ss	051000-MNA	M20x1.5	0.591	0.118	0.335	0.315	0.551	2.205	0.008	0.035	0.945	1.063	21/15
0s-20s	0510-0S-MNA	M20x1.5	0.591	0.276	0.472	0.315	0.551	2.323	0.008	0.049	0.945	1.063	21/15
0-20s	0510-0-MNA	M20x1.5	0.591	0.276	0.472	0.453	0.630	2.323	0.008	0.049	0.945	1.063	21/15
1-20	051001-MNA	M20x1.5	0.591	0.354	0.591	0.492	0.807	2.874	0.008	0.049	1.063	1.181	21/15
2s-25s	051022-MNA	M25x1.5	0.591	0.433	0.689	0.630	0.965	3.228	0.008	0.063	1.378	1.535	30/22
2-25	051002-MNA	M25x1.5	0.591	0.551	0.787	0.709	1.063	3.228	0.008	0.063	1.378	1.535	30/22
3s-32s	051033-MNA	M32x1.5	0.591	0.591	0.866	0.787	1.201	3.701	0.008	0.079	1.654	1.850	42/31
3-32	051003-MNA	M32x1.5	0.591	0.748	1.043	0.906	1.319	3.701	0.008	0.079	1.654	1.850	42/31
4s-40s	051044-MNA	M40x1.5	0.591	0.866	1.240	1.043	1.535	3.937	0.012	0.079	2.047	2.323	52/38
4-40	051004-MNA	M40x1.5	0.591	1.024	1.339	1.102	1.575	4.134	0.012	0.079	2.047	2.323	52/38
5s-50s	051055-MNA	M50x1.5	0.591	1.142	1.496	1.386	1.870	4.764	0.016	0.098	2.559	2.874	57/42
5-50	051005-MNA	M50x1.5	0.591	1.339	1.752	1.748	2.079	4.764	0.016	0.098	2.559	2.874	57/42
6s-63s	051066-MNA	M63x1.5	0.591	1.496	1.969	1.791	2.382	4.961	0.016	0.098	3.150	3.543	66/49
6-63	051006-MNA	M63x1.5	0.591	1.732	2.224	2.150	2.594	4.961	0.016	0.098	3.150	3.543	66/49
7s-75s	051077-MNA	M75x1.5	0.591	1.969	2.441	2.323	2.854	5.433	0.016	0.124	3.780	4.252	72/53
7-75	051007-MNA	M75x1.5	0.591	2.205	2.657	2.559	3.071	5.433	0.016	0.124	3.780	4.252	72/53
8-80	051008-MNA	M80x2.0	0.787	2.323	2.717	2.559	3.051	5.591	0.016	0.124	3.780	4.252	80/59
9s-90s	051099-MNA	M90x2.0	0.787	2.598	2.953	2.874	3.406	6.142	0.016	0.138	4.370	4.921	89/66
9-90	051009-MNA	M90x2.0	0.787	2.913	3.209	3.228	3.583	6.142	0.016	0.138	4.370	4.921	89/66
10-10	059110-MNA	M100x2.0	0.787	3.189	3.583	3.543	3.937	6.811	0.016	0.138	4.921	5.551	98/72

Dimensions are in inches.

FITTING INSTRUCTION

ENCLOSURES AND EQUIPMENT TO WHICH CABLE GLANDS ARE FITTED:-

- Must be made from materials which are compatible with the cable gland materials.
- Have a sealing area around the cable gland entry point with a surface roughness < Ra 6.3 µm.
- Have entries that are perpendicular to the enclosure face in the area where the cable gland will seal to within 2.5°.
- Are sealed using the supplied sealing gasket (parallel threads) or by fully tightening into a threaded entry (tapered threads). Note that for tapered threads the IP rating can be improved to IP68 with the use of a suitable thread sealant.

MUST HAVE THREADED ENTRIES

- The same thread size as the cable gland. (Thread adapters should be used to correct

any mismatch).

- With a thread tolerance of metric class '6H' or equivalent.
- Where the thread length is a minimum of 10mm for Ex d applications or 3mm for all other applications

OR CLEARANCE HOLES (not Ex d)

- Where the hole size is the thread nominal size with a tolerance of +0.1 to +0.7mm. (e.g. the clearance hole for an M20 thread will have a diameter between 20.1mm and 20.7mm).
- Through material that is between 1mm and 12mm thick. (Thicker materials can be accommodated using glands with extended entry threads.)

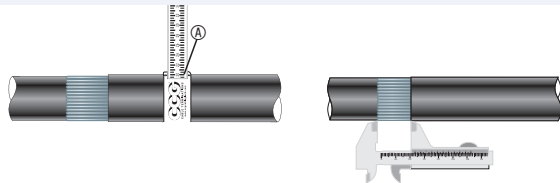

Gland Size	Armour Length	Gland Size	Armour Length	Gland Size	Armour Length	Gland Size	Armour Length
00-16ss	20.0	3s-32s	30.0	6s-63s	45.0	9-90	50.0
00-20ss	20.0	3-32	30.0	6-63	45.0	10-100	60.0
0-20s	20.0	4s-40s	30.0	7s-75s	50.0	11-115	60.0
1-20	25.0	4-40	30.0	7-75	50.0	12-120	60.0
2s-25s	25.0	5s-50s	35.0	8-80	50.0	13-130	60.0
2-25	25.0	5-50	35.0	9s-90s	50.0		

- For accurate sizing, use a CCG Dimension Tape [Ⓐ] on the inner and outer cable sheath. Cut back the cable outer sheath to expose the armour to a length as per the table above.

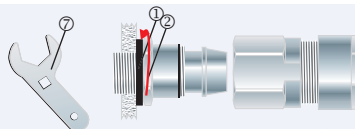

If the gland has NPT entry threads fitted to a threaded entry, then IP68 (2m) can be achieved by applying one of the following tested and approved grease types to the thread: - Renolit Lubrene CA700 or LX220 EP2, Renolit LC-WP2 or Moly LX2, or Dow Corning 4 Electrical Compound.

Alternative installation through an unthreaded entry.

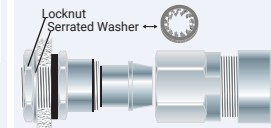

If the apparatus is untapped use a locknut.

- To maintain IP66/68 ensure the gasket ^① is in place. Screw the inner ^② into the apparatus. Tighten the inner ^② to the installation torque using a CCG Spanner ^⑦.

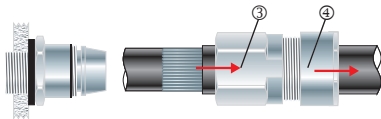

- Pass the outer nut ^④ and the body ^③ over the cable.

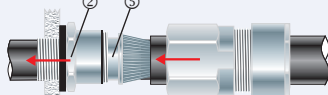

- Pass the cable end through the inner ^②. Splay the armour wires over the cone ^⑤.

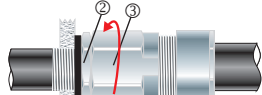

- Tighten the body ^③ onto the inner ^② until hand tight, then tighten with a CCG Spanner ^⑦ with 3/4 turn to lock the armour between the cone ^⑤ and the cone ring ^⑥.

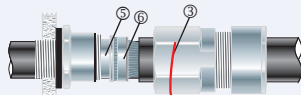

- Unscrew the body ^③. Check that the armour has locked between the cone ^⑤ and cone ring ^⑥. (O-Ring on the cone ring ^⑥ is sacrificial).

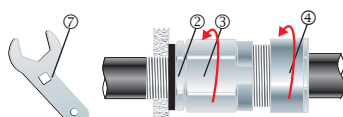

- Tighten the body ^③ onto the inner ^② to the installation torque using a CCG Spanner ^⑦. The Variable Deluge Seal™ will engage automatically as the body ^③ is tightened onto the inner ^②. Tighten the outer nut ^④ to produce a moisture proof seal by turning until the seal makes contact with the outer sheath of cable and then make one full turn.