

CW INTEGRAL EARTH INSULATED CAPTIVE COMPONENT GLAND®

for Steel Wire and Aluminium Armoured Cable

Features and Benefits

- For indoor and outdoor use.
- Insulated from equipment to prevent system circulating currents. Includes an integral earth connection for HV system circuits where high earth fault currents may be experienced.
- Two-piece handling, no loose parts.
- Freely rotating captive cone and inspectible cone ring, providing an armour clamp and earth bond without twisting the armouring.
- Patented disconnect armoured clamp system for ease of inspection
- Provides a seal on the outer sheath of the cable sealing to IP65/66.
- Precision manufactured from high-quality brass (nickel plated) available in aluminium or stainless steel 316/316L on request.
- Complete with thread sealing gasket, earthing stud, bolt and heavy-duty (nickel plated) locknut.



Technical Data

Type:	CW IE (Integral Earth) Insulated
Gland Material:	Brass (Nickel Plated), BS 2874, EN 12164, Aluminium ASTM B221, Stainless Steel 316/316L
Seal Material:	Thermoset Elastomer or Silicone on request
Cable Type:	Steel Wire Armour and Aluminium Armour Wire
Armour Clamping:	Rotating Captive Cone and Inspectible Cone Ring
Sealing Area:	Outer Sheath
Optional Accessories:	Adaptor, Reducer, Locknut, Earth Tag, Serrated Washer and Shroud

Standards and Certifications

Mechanical Properties:	Impact Category 8 Anchorage Type D	
Electrical Properties:	Category C	
Current Rating:	BS 6121:Part 5, IEC 62444 Size 20s to 40: 26kA one second Size 50s and above: 43kA one second	
Continuous Operating Temp:	-65°C to +120°C	
Conformance:	Standard: Certificate:	
Design Standards	BS 6121:Part 1 IEC/BS EN 62444 SANS 62444 SANS 1213	CML 14CA364 CML 14CA364 MASC 22-9012 MASC 18-2047, SANS 2109/4596 MASC 22-9015
IP66 - Parallel	IEC 60529	
IP65 - Tapered	IEC 60529	
Marine ABS	IEC 60529, IEC 62444	ABS 20-SG1952694-PDA
DNV	IEC 60529, BS 6121, IEC 62444	TAE000000Z
EMC Compatible	EN 55011, + A1, EN 55022	SGS EMC305079/1
London Underground Approval	BS EN 62444	LU 3043

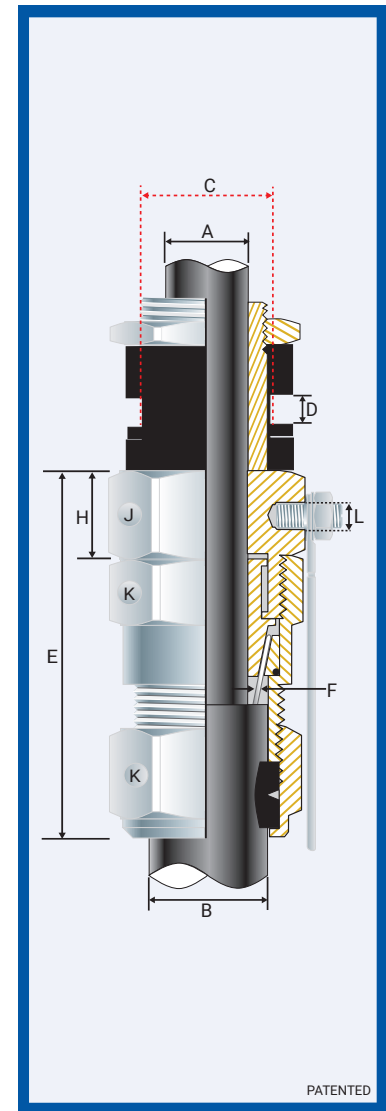

Installation Standards

- AS/NZS 3000
- BS 6121-5
- BS 7671
- BS 7430
- IEC 60364-5-54
- SANS 0142

Product Code	Gland Size Ref	Metric Entry Thread		Cable Detail			Max Length 'E'	Armour Dia		Hexagonal Detail					Earth Bolt 'L'	Install. Torque Nm
		'C'	Min 'D'	Max 'A'	Min 'B'	Max 'B'		Min 'F'	Max 'F'	Flats 'J'	Crns 'J'	Flats 'K'	Crns 'K'	Thick 'H'		
0580-0	0-20s	M20x1.5	10	12.0	11.5	16.0	61.0	0.90	1.25	24.0	27.0	24.0	27.0	15.0	M6/M8	35.0
058001	1-20	M20x1.5	10	13.5	14.5	20.5	67.0	0.90	1.25	27.0	30.0	27.0	30.4	15.0	M6/M8	35.0
058002	2-25	M25x1.5	10	17.5	20.5	26.5	80.0	1.25	1.60	42.0	47.0	35.0	39.4	15.0	M8/M10	50.0
058003	3-32	M32x1.5	10	24.0	26.5	33.5	80.0	1.60	2.00	50.0	56.0	42.0	47.3	20.0	M12	70.0
058004	4-40	M40x1.5	10	34.0	33.0	42.5	85.0	1.60	2.00	52.0	59.0	52.0	58.5	20.0	M12	90.0
058005	5-50	M50x1.5	10	42.5	42.5	52.5	106.0	2.00	2.50	65.0	73.0	65.0	73.1	22.0	M12	100.0
058006	6-63	M63x1.5	10	55.5	52.5	65.5	130.0	2.00	2.50	80.0	90.0	86.0	96.8	25.0	M12	120.0
058007	7-75	M75x1.5	10	68.0	65.5	78.0	150.0	2.50	3.15	111.0	125.0	96.0	102.0	25.0	M12	120.0
058008	8-80	M80x2.0	10	72.5	78.0	82.0	150.0	2.50	3.15	111.0	125.0	96.0	102.0	25.0	M12	120.0
058009	9-90	M90x2.0	10	81.5	82.0	91.0	160.0	3.00	3.50	111.0	125.0	111.0	124.9	40.0	M12	120.0
058010	10-100	M100x2.0	10	91.5	90.0	100.0	165.0	3.00	3.50	125.0	141.0	125.0	140.6	40.0	M12	120.0

All dimensions except NPT are in mm. * Customers to specify M6 or M8.

• When manufactured in Aluminium, Hex will be 27 Across Flats and 30 Across Corners.

CCG reserves the right to make alterations to the technical data, dimensions, designs and products available without notice. The illustrations cannot be considered binding. Please contact CCG for assistance.

CWEINS-PEG010424E

CW INTEGRAL EARTH INSULATED GLAND

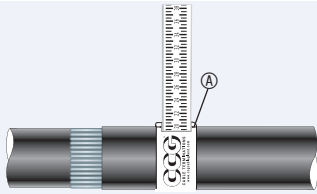

1. For accurate sizing, use a CCG Dimension Tape ④ on the inner and outer cable sheath.

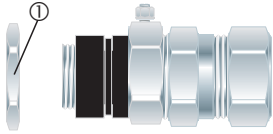

2. Remove the locknut ①.

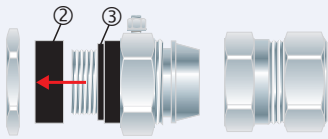

3. Remove female insulator ring ②. To maintain IP66, ensure the gasket ③ is in place.

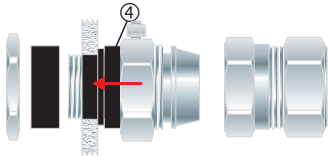

4. Insert the male insulator entry ④ into the cable entry of the apparatus.

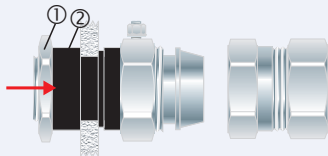

5. Screw the female insulator ring ② back against the apparatus (maximum of 10mm thickness). Screw the locknut ① back against the female insulator ring ② do not overtighten.

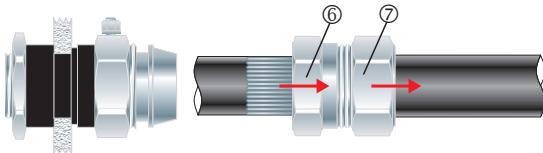

6. Pass the outer nut ⑦ and the body ⑥ over the cable and strip the cable outer sheath.

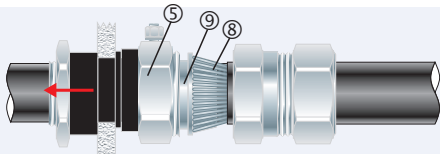

7. Pass cable end through the inner ⑤ and splay the armour wires ⑧ over the cone ⑨.

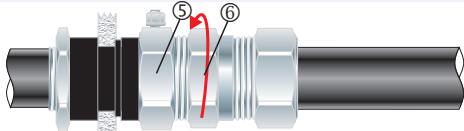

8. Hold the inner ⑤ with a CCG Spanner ⑪ and then tighten the body ⑥ using a second CCG Spanner ⑪ to the torque values shown to lock the armour ⑧ between the cone ⑨ and the cone ring ⑩.

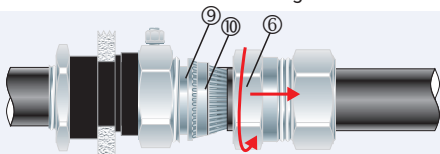

9. Unscrew the body ⑥. Check that the armour ⑧ has locked between the cone ⑨ and cone ring ⑩. (O-Ring on the cone ring ⑩ is sacrificial).

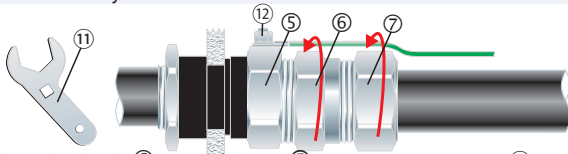

10. Tighten the body ⑥ onto the inner ⑤ using a CCG Spanner ⑪. Tighten the outer nut ⑦ onto the body ⑥ to produce a moisture-proof seal by turning until seal makes contact with the outer sheath of the cable and then turn one full turn. Connect earth wire / lug to earth stud ⑫.