

# IPLUS™ CORROSION GUARD™

## CAPTIVE COMPONENT GLAND®



for Steel Wire and Aluminium Armoured Cable

### Features and Benefits

- For highly corrosive and wet locations.
- Factory-fitted captive elastomeric seals for Built-in Safety™.
- The screw-on Corrosion Guard™ is manufactured from non-corrosive material to protect the armour and metal parts of the gland.
- Corrosion Guard™ screws onto the gland body and seals over the outer sheath of the cable giving an IP66/68 and deluge-proof seal.
- Cable Gland is precision manufactured from high-quality brass (Nickel Plated).
- Complete with sealing gasket and with a heavy-duty locknut.



### Technical Data

Type:	IPlus™ Corrosion Guard™
Gland Material:	Brass (Nickel Plated) BS 2874, EN 12164
Corrosion Guard Material:	Glass Reinforced Polyester Compound / PBT
Sealing Material:	Thermoset Elastomer (Standard)
Cable Type:	Steel Wire Armour, Aluminium Armour Wire
Armour Clamping:	Captive Rotating Cone and Inspectible Cone Ring
Sealing Area:	Inner and Outer sheath and total enclosure of the metal gland body
Optional Accessories:	Adaptor, Reducer, Locknut and Serrated Washer

### Standards and Certifications

Mechanical Properties:	Impact Category 8 Anchorage Type D	
Electrical Properties:	Category A (no earth tag) Category B (with earth tag)	
Continuous Operating Temp:	-65°C to +120°C	
Conformance:	Standard: Certificate:	
Design Standards	BS 6121: Part 1 EN 50262 IEC/BS EN 62444 SANS 62444 SANS 1213 IEC 60529	CML 14CA364 CML 14CA364 CML 14CA364 MASC 22-9012 MASC 26-9013, SANS 2109/4596 CML 15Y728 / MASC 22-9015
IP66/68 100m	IEC 60529	MASC 15Y728 / MASC 22-9015
Corrosion Protection	ASTM B117-11, BS EN ISO 3231	N968667
Marine ABS	IEC 62444	25-0167207-PDA
DNV	IEC 60529, BS 6121, IEC 62444	TAE000000Z
EMC Compatible	EN 55011, + A1, EN 55022	SGS EMC305079/1
London Underground Approval	BS EN 62444	LU 3043

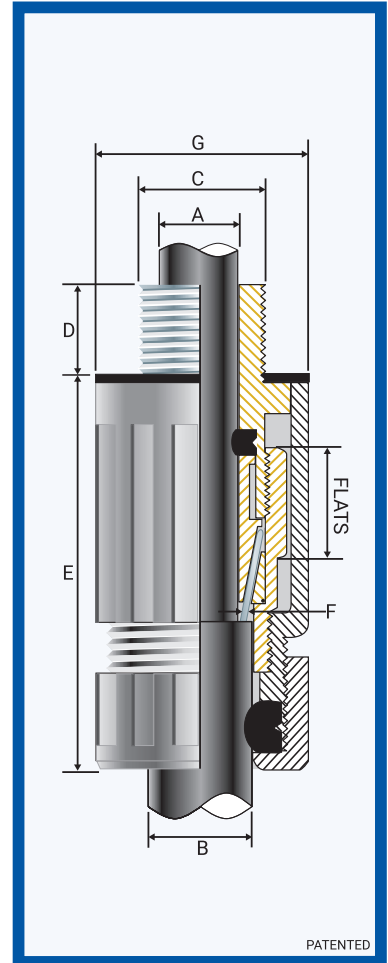

### Installation Standards

- AS/NZS 3000
- BS 6771
- IEC 60364-5-54
- BS 6121-5
- BS 7430
- SANS 0142

Product Code	Gland Size Reference	Metric Entry Thread		Cable Detail				Max Length 'E'	Armour Dia		Max Dia 'G'	Hexagonal Detail		Installation Torque Value Nm
		'C'	Min 'D'	Min 'A'	Max 'A'	Min 'B'	Max 'B'		Min 'F'	Max 'F'		Max 'Flats'	Max 'Crns'	
054600-16-IP*	00-16ss	M16x1.5	10	3.0	8.5	8.0	13.5	50.0	-	0.90	35.0	24.0	27.0	35.0
054600-IP*	00-20ss	M20x1.5	10	3.0	8.5	8.0	13.5	50.0	-	0.90	35.0	24.0	27.0	35.0
0546-0-IP*	0-20s	M20x1.5	10	7.0	11.5	11.5	16.0	50.0	0.90	1.25	35.0	24.0	27.0	35.0
054601-IP	1-20	M20x1.5	10	11.0	15.0	14.5	20.5	61.0	0.90	1.25	36.5	27.0	30.0	35.0
054622-IP	2s-25s	M25x1.5	10	11.0	17.5	16.0	24.5	68.0	1.25	1.60	46.0	35.0	39.0	50.0
054602-IP	2-25	M25x1.5	10	14.0	20.0	20.5	26.5	68.0	1.25	1.60	46.0	35.0	39.0	50.0
054633-IP	3s-32s	M32x1.5	10	15.0	22.0	23.0	30.5	75.0	1.60	2.00	53.0	42.0	47.0	70.0
054603-IP	3-32	M32x1.5	10	19.0	26.5	26.5	33.5	75.0	1.60	2.00	53.0	42.0	47.0	70.0
054644-IP	4s-40s	M40x1.5	15	22.0	31.5	30.0	39.5	86.0	1.60	2.00	68.0	52.0	59.0	90.0
054604-IP	4-40	M40x1.5	15	26.0	34.0	33.0	42.5	86.0	1.60	2.00	68.0	52.0	59.0	90.0
054655-IP	5s-50s	M50x1.5	15	29.0	38.0	34.0	47.5	102.0	2.00	2.50	84.0	65.0	73.0	100.0
054605-IP	5-50	M50x1.5	15	34.0	44.5	42.5	52.5	102.0	2.00	2.50	84.0	65.0	73.0	100.0
054666-IP	6s-63s	M63x1.5	15	38.0	50.0	45.5	60.5	122.0	2.00	2.50	110.0	80.0	90.0	120.0
054606-IP	6-63	M63x1.5	15	44.0	56.5	52.5	65.5	122.0	2.00	2.50	110.0	80.0	90.0	120.0
054677-IP	7s-75s	M75x1.5	15	50.0	62.0	57.0	72.5	135.0	2.00	3.15	124.0	96.0	102.0	120.0
054607-IP	7-75	M75x1.5	15	56.0	67.5	65.5	78.0	135.0	2.00	3.15	124.0	96.0	102.0	120.0
054608-IP	8-80	M80x2.0	20	68.0	69.0	65.0	77.5	160.0	2.50	3.15	124.0	96.0	102.0	120.0
054699-IP	9s-90s	M90x2.0	20	66.0	75.0	73.0	86.5	170.0	3.00	3.50	140.0	111.0	125.0	120.0
054609-IP	9-90	M90x2.0	20	74.0	81.0	82.0	91.0	170.0	3.00	3.50	140.0	111.0	125.0	120.0
054610-IP	10-100	M100x2.0	20	81.0	91.0	90.0	100.0	180.0	3.00	3.50	140.0	125.0	141.0	120.0

All dimensions are in mm.

# IP PLUS™ CORROSION GUARD™ GLAND

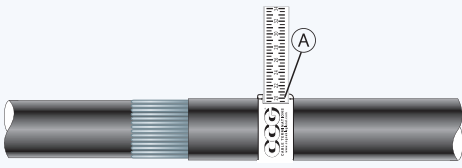

1. For accurate sizing, use a CCG Dimension Tape (A) on the inner and outer cable sheath.

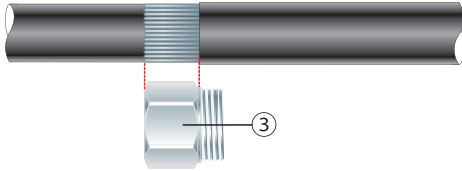

2. Cut back the cable outer sheath to expose the armour to a length not more than the body (3).

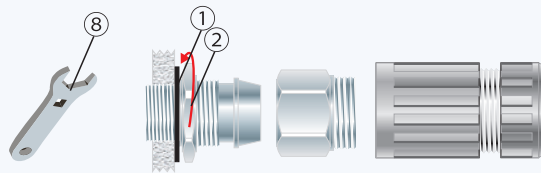

3. To maintain IP66/68, ensure gasket (1) is in place. Screw the inner (2) into the apparatus. Tighten the inner (2) to the installation torque using a CCG Spanner (8). For untapped entries use a locknut.

Alternative installation through an unthreaded entry.

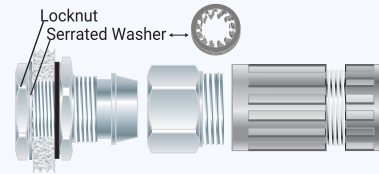

If the apparatus is untapped use a locknut.

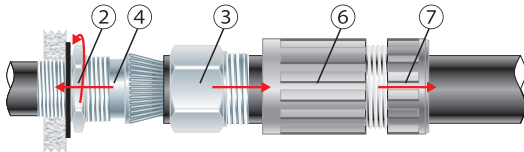

4. Pass the corrosion guard outer nut (7), corrosion guard body (6) and the body (3) over the cable. Pass the cable end through the inner (2) and splay the armour wires over the cone (4).

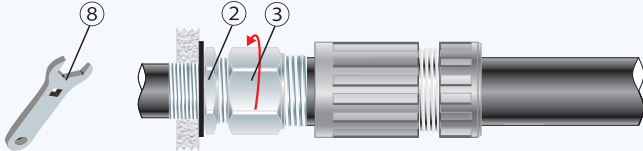

5. Tighten the body (3) onto the inner (2) until hand tight, then tighten with a CCG Spanner (8) with  $\frac{3}{4}$  turn to lock the armour between the cone (4) and the cone ring (5).

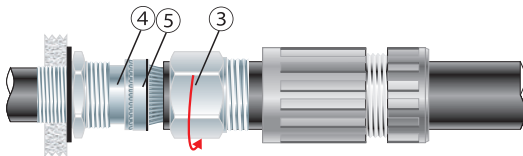

6. Unscrew the body (3). Check that the armour has locked between the cone (4) and cone ring (5). (O-Ring on the cone (4) and cone ring (5) are sacrificial).

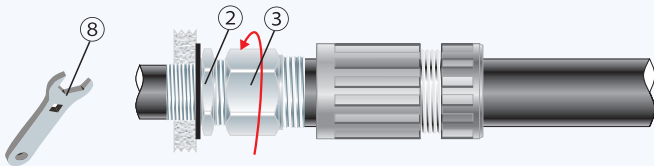

7. Tighten the body (3) onto the inner (2). Tighten the body (3) to installation torque using a CCG Spanner (8).

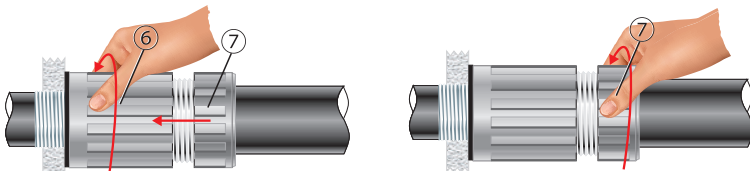

8. Slide corrosion guard body (6) and corrosion guard outer nut (7) over assembled gland, screw corrosion guard body (6) onto the gland. **Hand tighten** corrosion guard body (6) and corrosion guard outer nut (7) to produce the required dust and waterproof seal IP66/68.