



# E1W INSULATED CAPTIVE COMPONENT GLAND®

for Steel Wire and Aluminium Armoured Cable

## Features and Benefits

- For indoor and outdoor use.
- Gland is insulated from the equipment to prevent system circulating currents.
- Freely rotating captive cone and inspectible cone ring, providing an inspectible armour clamp and earth bond without twisting the armouring.
- Patented disconnect armoured clamp system for ease of inspection
- Provides a seal on the inner and outer sheath of the cable, sealing to IP66.
- Precision manufactured from high-quality Brass (nickel plated), available in Aluminium or Stainless Steel 316/316L on request.
- Supplied with a thread-sealing Basket and a heavy-duty (nickel-plated) Locknut.



## Technical Data

Type:	E1W Insulated
Gland Material:	Brass (Nickel Plated), BS 2874, EN 12164, Aluminium ASTM BS221, Stainless Steel 316/316L
Seal Material:	Thermoset Elastomer or Silicone on request
Cable Type:	Steel Wire Armour and Aluminium Armour Wire
Armour Clamping:	Rotating Captive Cone and Inspectible Cone Ring
Sealing Area:	Inner Sheath and Outer Sheath
Optional Accessories:	Adaptor, Reducer, Earth Tag, Locknut, Serrated Washer and Shroud

## Standards and Certification

Mechanical Properties:	Impact Category 8 Anchorage Type D	
Continuous Operating Temp:	-65°C to +120°C	
Conformance:	Standard:	Certificate:
Design Standards	BS 6121: Part 1 IEC/BS EN 62444 SANS 62444 SANS 1213	CML 14CA364 CML 14CA364 MASC 22-9012 MASC 26-9013, SANS 2109/4596 MASC 22-9015
IP66 - Parallel	IEC 60529	25-0167207-PDA
Marine ABS	IEC 62444	TAE000000Z
DNV	IEC 60529, BS 6121, IEC 62444	SGS EMC305079/1
EMC Compatible	EN 55011, + A1, EN 55022	LU 3044
London Underground Approval	BS EN 62444	

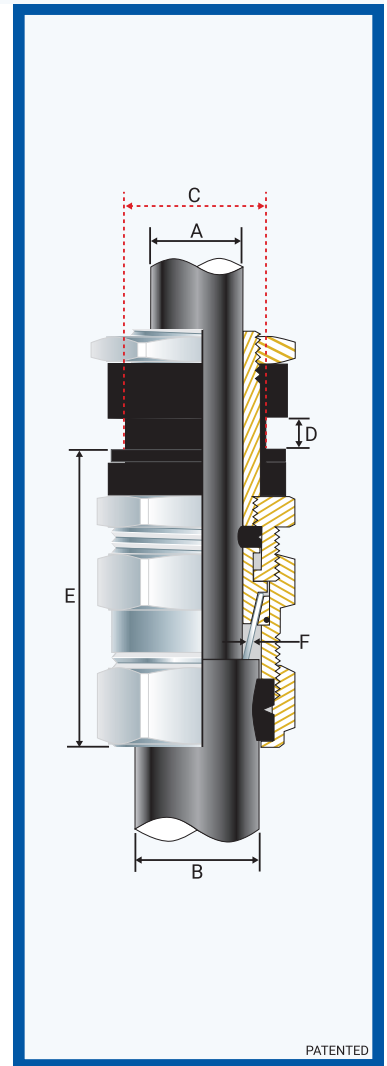

## Installation Standards

- AS/NZS 3000
- BS 7430
- BS 6121-5
- IEC 60364-5-54
- BS 7671
- SANS 0142

Product Code	Gland Size Ref	Metric Entry Thread		Cable Detail				Max Length 'E'	Armour Dia		Hexagonal Detail		Installation Torque Value Nm
		'C'	Max 'D'	Min 'A'	Max 'A'	Min 'B'	Max 'B'		Min 'F'	Max 'F'	Max 'Flats'	Max 'Crns'	
0558-0	0-20s	20	10	7.0	12.0	11.5	16.0	46.5	0.90	1.25	♦ 24.0	♦ 27.0	35.0
055801	1-20	20	10	11.0	15.0	14.5	20.5	56.0	0.90	1.25	27.0	30.0	35.0
055822	2s-25S	25	10	11.0	17.5	16.0	24.5	73.0	1.25	1.60	27.0	30.0	50.0
055802	2-25	25	10	14.0	20.0	20.5	26.5	74.0	1.25	1.60	35.0	39.0	50.0
055833	3s-32s	32	10	15.0	22.0	23.0	30.5	64.0	1.60	2.00	35.0	39.0	70.0
055803	3-32	32	10	19.0	26.5	26.5	33.5	63.0	1.60	2.00	42.0	47.0	70.0
055844	4s-40s	40	10	22.0	31.5	30.0	39.5	78.0	1.60	2.00	42.0	47.0	90.0
055804	4-40	40	10	26.0	34.0	33.0	42.5	77.5	1.60	2.00	52.0	59.0	90.0
055855	5s-50s	50	10	29.0	38.0	34.0	47.5	103.0	2.00	2.50	52.0	59.0	100.0
055805	5-50	50	10	34.0	44.5	44.5	52.5	93.0	2.00	2.50	65.0	73.0	100.0
055866	6s-63s	63	10	38.0	50.0	50.0	60.5	114.0	2.00	2.50	65.0	73.0	120.0
055806	6-63	63	10	44.0	56.5	56.5	65.5	114.0	2.00	2.50	80.0	90.0	120.0
055877	7s-75s	75	10	50.0	62.0	62.0	72.5	127.0	2.50	3.15	80.0	90.0	120.0
055807	7-75	75	10	56.0	67.5	67.5	78.0	127.0	2.50	3.15	96.0	102.0	120.0

All dimensions are in mm.

♦ When manufactured in Aluminium, Hex will be 27 Across Flats and 30 Across Corners.

### E1W INSULATED CAPTIVE COMPONENT GLAND®

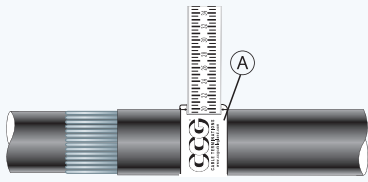

1. For accurate sizing, use a CCG Dimension Tape (A) on the inner and outer cable sheath.

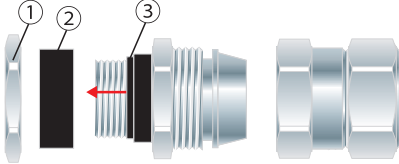

2. Remove the locknut (1) and the female insulator ring (2). To maintain IP66/68 ensure the gasket (3) is in place.

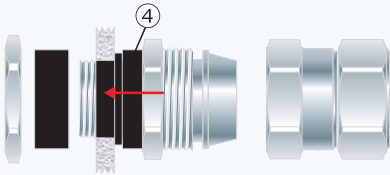

3. Insert the male insulator entry (4) into the cable entry of apparatus.

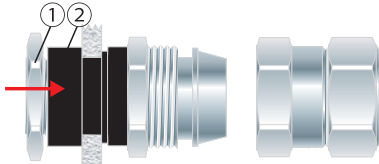

4. Screw the female insulator ring (2) back against the apparatus (maximum of 10mm thickness). Screw the locknut (1) back against the female insulator ring (2).

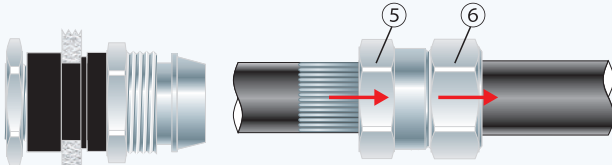

5. Pass the outer nut (6) and the body (5) over the cable.

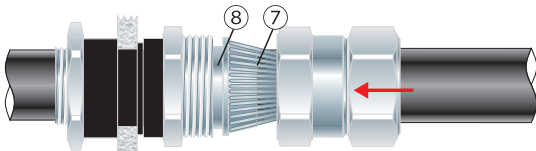

6. Pass the cable end through the inner and splay the armour wires (7) over cone (8).

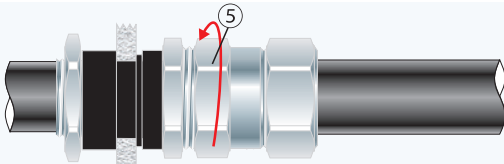

7. Screw the body (5) onto the inner and tighten the body (5) to lock the armour between the cone (8) and the cone ring (9).

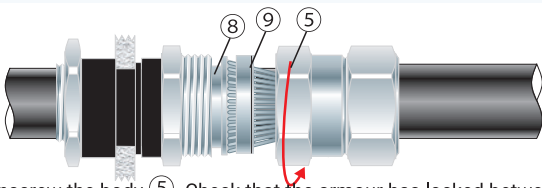

8. Unscrew the body (5). Check that the armour has locked between the cone (8) and the cone ring (9). (O-Rings on the cone (8) and cone ring (9) are sacrificial).

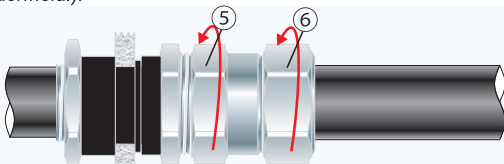

9. Tighten the body (5) onto the inner. Tighten the outer nut (6) to produce a moisture-proof seal by turning until the seal makes contact with the outer sheath of cable and make one full turn.